

ClassicSeries

by Thermo-Tech

Classic Comfort
And Beauty

Designed and manufactured to provide cost-saving energy efficiency, exceptional safety and security, and greater comfort all year long.



*Your satisfaction
is reflected in
everything we do.*

 **Thermo-Tech**
Premium Windows and Doors

ttwindows.com • 877-565-0159

Classic Style For New Construction Projects

At Thermo-Tech[®], we build exceptional quality into all of our Classic Series Premium Windows, so homeowners can expect more energy savings. More maintenance-free performance. More comfort. Thermo-Tech Classic Series Windows are expertly designed and manufactured to provide cost-saving energy efficiency, exceptional safety and security, and greater comfort and beauty

all year long. Thermo-Tech Classic Series Windows are made with strong, premium grade materials that help keep the weather outside and comfort inside. They're also unbelievably easy to operate and clean — inside and out. Plus, they require very little maintenance and will maintain their attractive appearance and ease-of-use for decades to come.



 **Thermo-Tech[®]**
Premium Windows and Doors

Your satisfaction is reflected in everything we do.

Proven Energy Efficiency

Exceptional Design Flexibility

Maintenance-Free Durability

Green Building Solutions

All Thermo-Tech windows are made of vinyl, a sustainable, environmentally friendly material that lasts. Building products made of other materials, like wood, may seem to be greener solutions, but in reality they are less energy efficient. They also break down many times faster than vinyl, which means they need to be replaced more often – requiring more energy consumption. Plus, our products need no additional paint, stain, stripper, thinner or other solvents. Completely recyclable, vinyl simply makes environmental sense.

Thermo-Tech windows have options that meet or exceed the requirements of ENERGY STAR® - a very significant ingredient to meeting green building criteria.



Energy Efficiency

Thermo-Tech helps reduce your home energy use with high-performance technology built into every Thermo-Tech window. Multiple chambers inside the frame trap air for superb insulation against heat loss. LoE glass options can be selected that meet or surpass minimum requirements of ENERGY STAR while providing superior protection for your home's interior, including fading caused by the sun.

Reliability/Flexibility

Thermo-Tech Classic Series Windows for new construction are designed to fit your home and you. With multiple styles, custom shapes, maintenance-free wood laminates or 3 vinyl colors, Thermo-Tech windows accommodate your design preferences, your project, your budget and your lifestyle.

What's Inside:

| | |
|---|----|
| Features and Options | 4 |
| Energy & Structural Performance Data | 6 |
| Slider Windows | 8 |
| 3-Lite Slider Windows | 9 |
| Utility Units | 9 |
| Casement Windows | 10 |
| Window Opening Control Devices (WOCDs) | 14 |
| Fixed Casement & Direct-Set Windows | 16 |
| Awning Windows | 18 |
| Double-Hung Windows | 20 |
| Single-Hung Windows | 21 |
| Cottage Style Windows | 22 |
| Oriel Style Windows | 23 |
| Picture Windows with Flanking Units | 24 |
| Bow Windows | 26 |
| Bay Windows | 28 |
| Fixed Casement & Direct-Set Transoms | 34 |
| Half Round & Quarter Round Windows | 36 |
| Ellipse & Extended Eyebrow Windows | 37 |
| Standard & Non-Standard Specialty Windows | 38 |
| Warranty Information | 39 |



Built To Fit Your Style

Thermo-Tech Classic Series Windows feature smart design, durable construction and maintenance-free vinyl. They come standard with white vinyl, matching hardware and double-pane insulated high-performance, argon-filled LoE glass. Combine other options to create a truly custom vinyl window solution to fit your specific needs and lifestyle.

It Starts With Insulated Glass

Choose our standard double-pane insulated High-Performance glass, or select our Premium or Ultimate High-Performance options designed to meet a variety of needs.

Premium High-Performance heat reflecting glass adds even more insulating power for a balance of solar control, thermal performance, high visibility, and additional fade protection.

For the greatest thermal performance of all double-pane options, Thermo-Tech's Ultimate High-Performance glass option delivers a "twin punch". It offers all the benefits of our Premium option while maximizing thermal performance.

Sandlewood vinyl slider window
(exterior view)

100% virgin super-insulating PVC

Fusion-welded corners enhance strength and durability

Interior and exterior accessory grooves to make add-ons a "snap"

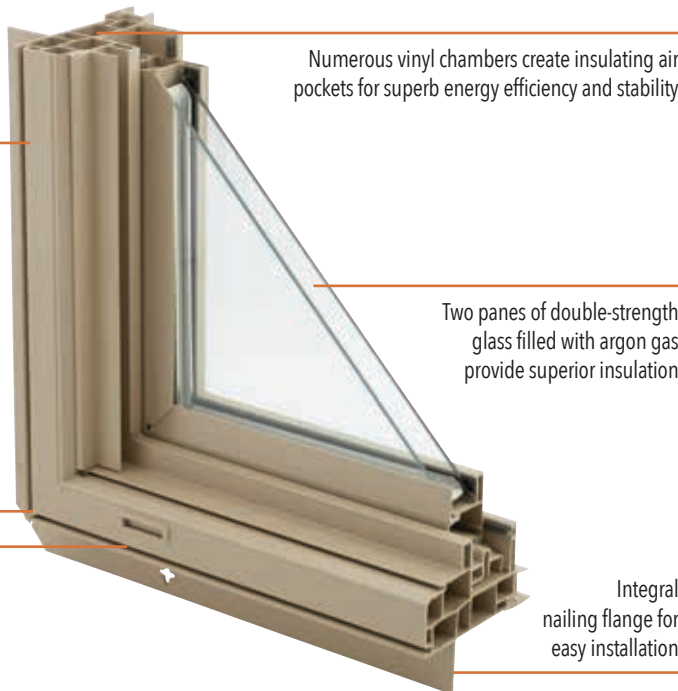

Thermo-Tech® WARM-EDGE ADVANTAGE

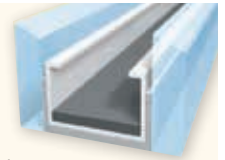

For the longest-lasting comfort and energy savings, Thermo-Tech insulated glass incorporates warm edge Intercept® glass spacer systems.

- For added insulating value and durability, no other type of thermal design brings these combined advantages
- Patented U-shape construction extends window life
- Best argon retention
- ENERGY STAR® performance
- Recessed below the sightline so all you ever see are beautiful windows

DURABILITY ADVANTAGE

Our warm-edge spacer flexes instead of the sealant during temperature changes, so it resists seal failures better.

OTHERS

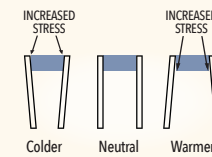

OURS

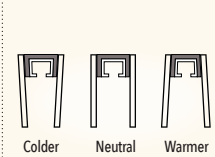

Glass Options

All Thermo-Tech Classic Series Windows come standard with double strength, High-Performance LoE, argon filled insulated glass.

GLASS OPTION UPGRADES INCLUDE:

- Ultimate High-performance LoE³™ 366/Argon/189
- Premium High-performance LoE³™ 366/Argon
- Energy Guard PLUS Triple LoE²™ 272/Argon
- Energy Guard Triple LoE³™ 366/Argon
- Grids between the glass
- Obscure
- Tempered safety glass
- Grey and bronze tint

Why Premium Or Ultimate High-Performance LoE Glass?

- Lowers energy costs = saving on heating bill
- Blocks 95% of harmful UV rays = reduced fading on carpet, furniture, etc
- Year round comfort = cooler in summer, warmer in winter
- Average heat loss reduction compared to standard double-pane glass is 50%
- Elevates dual pane performance to R4 plus with LoE³™ 366/Argon/189

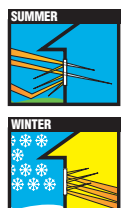

EnergyGuard by Thermo-Tech

TRIPLE-PANE WINDOW

For maximum energy savings and optimal sun protection, step up to Energy Guard triple-pane insulated glass.

Available in casements, awnings, fixed-casements, direct-set picture windows, and shapes.



(exterior view)

Exterior Frame Options

Thermo-Tech Classic Series Windows are available in three exterior colors to match virtually any home style or color. Choose from standard White or upgrade to Tan or Sandlewood



Thermo-Tech Classic Series Windows STANDARD FEATURES & BENEFITS

- Thermo-Tech Classic Series Windows feature standard window sizes (*Custom sizes available with our Thermo-Fit window series*)
- Maintenance-free, all-vinyl construction
- Energy-efficient 3-1/4" multi-chambered frame design
- Sealed, insulated units with 3/4" double-strength glass
- Energy efficient warm-edge spacer system
- Fusion-welded corners for structural strength and durability
- Integrated nail fin for new construction

Custom Hardware Colors

Heavy-duty standard low-profile folding hardware is available in White, Tan or Sandlewood to match your window color, or in optional metallic finishes for a more elegant look.



STANDARD HARDWARE COLORS

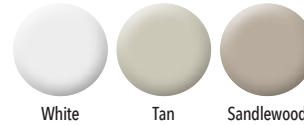

OPTIONAL METALLIC HARDWARE COLORS



Antique Brass available on Double-Hung, Single-Hung, Casement and Slider windows. Oil-Rubbed Bronze available on Double-Hung and Casement windows.

Interior Wood Laminate Colors

Get the warmth and classic beauty of wood with the comfort and ease-of-maintenance of vinyl. At Thermo-Tech, we never stop improving our vinyl windows and doors.

We always start with expert design, durable construction and maintenance-free 100% virgin vinyl. But it's the finishing touches that are turning heads - like our wood laminates featuring the warmth of wood and the maintenance-free insulating power of vinyl.

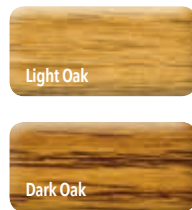

Wood laminates available with White or Sandlewood exteriors only.

Available on our Classic Patio Doors, Fixed Casements, Direct Set Picture Windows, Double-Hungs, Sliders, Casements, Awnings, and our Geometric and Radius Windows.

Extension Jamb

Extension jamba available in unfinished oak, pine and birch. Also available in three laminate colors and two oak laminates, light and dark oak, to match the interior frames for overall ease of a prefinished maintenance-free extension jamb.

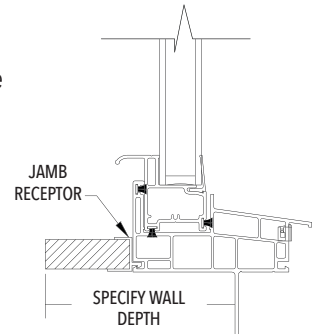

Jamb receptors come in three sizes: 1/2", 11/16" and 3/4" for various jamb thickness. The 11/16" is used for all standard Thermo-Tech jamba. The jamb receptors can be pre-installed for easy in-the-field extension jamb installation.

Distinctive Grid Styles

FLAT OR CONTOURED GRIDS CONFIGURATIONS

Flat or contoured grids between the glass are available in a variety of configurations and colors to match our vinyl windows.

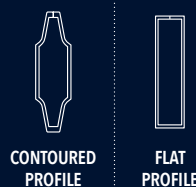

GRID PATTERNS

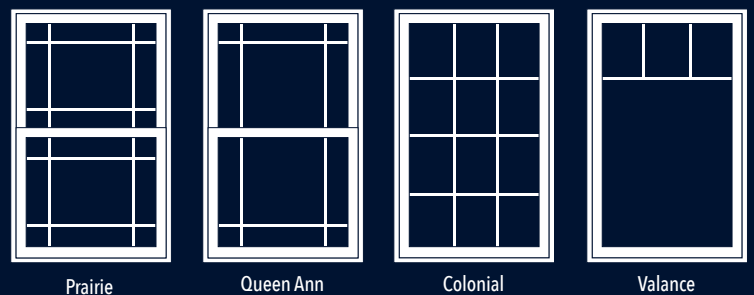

Easily Select The Right Windows



Thermo-Tech Classic Series Windows are thoroughly tested for structural and thermal performance to the most widely recognized national standards. This will ensure that our windows will provide a lifetime of reliable, energy saving performance.

When shopping for windows, make sure to compare structural and thermal performance ratings to ensure that you are purchasing reliable, energy-efficient windows.

Thermo-Tech Classic Series Windows are structurally tested to the American Architectural Manufacturers Association (AAMA) window specifications. When comparing structural performance of windows look for the performance grade (PG). Performance grade is a window's resistance to wind and rain. The higher the PG rating, the better.

Look for the National Fenestration Rating Council (NFRC) label for an accurate method to compare a product's energy performance and also ensure the windows are ENERGY STAR® compliant in your area.

Compare the U-Factor and the Solar Heat Gain Coefficient (SHGC) of the window. U-Factor is a measure of how well a window keeps heat inside a home or building in the winter. The lower the U-Factor, the greater the insulating value of the window. SHGC measures how well a window blocks heat caused by sunlight. The lower the window's SHGC, the less solar heat is allowed into the home by the window. Thermo-Tech's windows are ENERGY STAR rated in all four climate zones.

Environmentally Sensible Construction

Thermo-Tech values our environment. Manufacturing all vinyl products worldwide accounts for less than .3% of total oil and gas consumption. And completely recyclable, vinyl simply makes environmental sense.



The lower the U-Value and the higher the R-Value, the better the window is at reducing heat loss.

ULTIMATE HIGH PERFORMANCE LoE³™ 366/Argon/189™ Double insulated Glass with LoE³™ 366/Argon on one glass surface and 189™ on interior surface

| TYPE | GLASS TYPE | U-VALUE | R-VALUE | SOLAR HEAT GAIN NO/GRIDS | SOLAR HEAT GAIN W/GRIDS | VISIBLE LIGHT NO/GRIDS | VISIBLE LIGHT W/GRIDS | CONDENSATION RESISTANCE | U.S. ENERGY STAR ZONES NO/GRIDS | U.S. ENERGY STAR ZONES W/GRIDS |
|-------------------------------|-----------------------------------|---------|---------|--------------------------|-------------------------|------------------------|-----------------------|-------------------------|---------------------------------|--------------------------------|
| CASEMENT | LoE ³ ™ 366/Argon/189™ | .23 | 4.35 | .18 | .17 | .42 | .38 | 46 | All | All |
| HORIZONTAL SLIDERS | LoE ³ ™ 366/Argon/189™ | .25 | 4.00 | .22 | .20 | .50 | .44 | 44 | All | All |
| SINGLE-HUNG | LoE ³ ™ 366/Argon/189™ | .25 | 4.00 | .21 | .19 | .50 | .44 | 43 | All | All |
| DOUBLE-HUNG | LoE ³ ™ 366/Argon/189™ | .26 | 3.85 | .20 | .18 | .47 | .42 | 43 | All | All |
| DIRECT-SET PICTURE WINDOW | LoE ³ ™ 366/Argon/189™ | .22 | 4.55 | .24 | .22 | .56 | .50 | 46 | All | All |
| FIXED CASEMENT PICTURE WINDOW | LoE ³ ™ 366/Argon/189™ | .22 | 4.55 | .21 | .19 | .50 | .44 | 45 | All | All |
| AWNING WINDOW | LoE ³ ™ 366/Argon/189™ | .23 | 4.35 | .18 | .17 | .42 | .38 | 45 | All | All |
| SLIM LINE PATIO DOOR | LoE ³ ™ 366/Argon/189™ | .25 | 4.17 | .22 | .19 | .51 | .44 | 42 | All | All |
| CLASSIC FRENCH PATIO DOOR | LoE ³ ™ 366/Argon/189™ | .26 | 3.85 | .19 | .16 | .43 | .37 | 44 | All | All |

PREMIUM HIGH PERFORMANCE LoE³™ 366/Argon Double insulated Glass with LoE³™ 366/Argon on one glass surface

| TYPE | GLASS TYPE | U-VALUE | R-VALUE | SOLAR HEAT GAIN NO/GRIDS | SOLAR HEAT GAIN W/GRIDS | VISIBLE LIGHT NO/GRIDS | VISIBLE LIGHT W/GRIDS | CONDENSATION RESISTANCE | U.S. ENERGY STAR ZONES NO/GRIDS | U.S. ENERGY STAR ZONES W/GRIDS |
|-------------------------------|------------------------------|---------|---------|--------------------------|-------------------------|------------------------|-----------------------|-------------------------|---------------------------------|--------------------------------|
| CASEMENT | LoE ³ ™ 366/Argon | .26 | 3.85 | .19 | .17 | .43 | .39 | 58 | All | All |
| HORIZONTAL SLIDERS | LoE ³ ™ 366/Argon | .29 | 3.45 | .22 | .20 | .51 | .46 | 55 | NC, SC, S | NC, SC, S |
| SINGLE-HUNG | LoE ³ ™ 366/Argon | .29 | 3.45 | .22 | .20 | .51 | .45 | 55 | NC, SC, S | NC, SC, S |
| DOUBLE-HUNG | LoE ³ ™ 366/Argon | .30 | 3.33 | .21 | .19 | .48 | .43 | 54 | NC, SC, S | NC, SC, S |
| DIRECT-SET PICTURE WINDOW | LoE ³ ™ 366/Argon | .26 | 3.85 | .24 | .22 | .57 | .51 | 58 | All | All |
| FIXED CASEMENT PICTURE WINDOW | LoE ³ ™ 366/Argon | .26 | 3.85 | .22 | .20 | .51 | .45 | 57 | All | All |
| AWNING WINDOW | LoE ³ ™ 366/Argon | .26 | 3.85 | .19 | .17 | .43 | .39 | 57 | All | All |
| SLIM LINE PATIO DOOR | LoE ³ ™ 366/Argon | .29 | 3.45 | .22 | .20 | .52 | .45 | 53 | All | All |
| CLASSIC FRENCH PATIO DOOR | LoE ³ ™ 366/Argon | .30 | 3.33 | .19 | .17 | .44 | .38 | 55 | All | All |

HIGH PERFORMANCE LoE²™ 272/Argon Double Insulated Glass with LoE²™ 272/Argon on One Glass Surface

| TYPE | GLASS TYPE | U-VALUE | R-VALUE | SOLAR HEAT GAIN NO/GRIDS | SOLAR HEAT GAIN W/GRIDS | VISIBLE LIGHT NO/GRIDS | VISIBLE LIGHT W/GRIDS | CONDENSATION RESISTANCE | U.S. ENERGY STAR ZONES NO/GRIDS | U.S. ENERGY STAR ZONES W/GRIDS |
|-------------------------------|------------------------------|---------|---------|--------------------------|-------------------------|------------------------|-----------------------|-------------------------|---------------------------------|--------------------------------|
| CASEMENT | LoE ² ™ 272/Argon | .27 | 3.70 | .28 | .26 | .48 | .43 | 58 | N, NC | N, NC |
| HORIZONTAL SLIDER | LoE ² ™ 272/Argon | .30 | 3.33 | .33 | .30 | .57 | .51 | 55 | NC | NC |
| SINGLE-HUNG | LoE ² ™ 272/Argon | .30 | 3.33 | .33 | .30 | .57 | .50 | 54 | NC | NC |
| DOUBLE-HUNG | LoE ² ™ 272/Argon | .31 | 3.23 | .31 | .28 | .54 | .48 | 54 | | |
| DIRECT-SET PICTURE WINDOW | LoE ² ™ 272/Argon | .27 | 3.70 | .37 | .33 | .64 | .57 | 57 | N, NC | N, NC |
| FIXED CASEMENT PICTURE WINDOW | LoE ² ™ 272/Argon | .27 | 3.70 | .33 | .30 | .56 | .50 | 57 | N, NC | N, NC |
| AWNING | LoE ² ™ 272/Argon | .27 | 3.70 | .28 | .26 | .48 | .43 | 57 | N, NC | N, NC |
| SLIM LINE PATIO DOOR | LoE ² ™ 272/Argon | .30 | 3.33 | .33 | .30 | .58 | .51 | 52 | N, NC | N, NC |
| CLASSIC FRENCH PATIO DOOR | LoE ² ™ 272/Argon | .30 | 3.33 | .29 | .25 | .49 | .42 | 54 | N, NC | All |

All tests conform to NFRC 100-2010, NFRC 200-2010, NFRC 400-2010, NFRC 500-2010 procedures.



STRUCTURAL PERFORMANCE DATA

| TYPE | SIZE TESTED | CLASS/PERFORMANCE GRADE | AIR INFILTRATION | WATER INFILTRATION | FORCED ENTRY |
|-------------------------------|-------------|-------------------------|------------------|--------------------|--------------|
| CASEMENT | 30 x 72 | LC - 50 | .03cfm/ft2 | 12.12 psf | Grade 10 |
| XO HORIZONTAL SLIDER | 72 x 48 | R - 40 | .07cfm/ft2 | 6.06 psf | Grade 10 |
| XOX 3-LITE HORIZONTAL SLIDER | 108 x 60 | LC - 30 | .09cfm/ft2 | 4.60 psf | Grade 10 |
| SINGLE-HUNG | 40 x 72 | R - 40 | .07cfm/ft2 | 6.06 psf | Grade 10 |
| DOUBLE-HUNG | 48 x 72 | R - 40 | .02cfm/ft2 | 6.06 psf | Grade 10 |
| DIRECT-SET PICTURE WINDOW | 72 x 72 | LC - 50 | .01cfm/ft2 | 12.12 psf | Grade 10 |
| FIXED CASEMENT PICTURE WINDOW | 72 x 72 | LC - 40 | .01cfm/ft2 | 12.12 psf | Grade 10 |
| AWNING | 48 x 39 | LC - 40 | .03cfm/ft2 | 12.12 psf | Grade 10 |
| SLIM LINE PATIO DOOR | 72 x 84 | R - 30 | .02cfm/ft2 | 7.5 psf | Grade 10 |
| CLASSIC FRENCH PATIO DOOR | 72 x 84 | LC - 40 | .08cfm/ft2 | 7.5 psf | Grade 10 |

The windows and doors described herein meets or exceeds the AAMA/WDMA/CSA101/I.S.2/A440-08.

Energy Guard PLUS Triple Insulated Glass (ENERGY STAR Most Efficient) Triple insulated glass with high-performance LoE™ 272/Argon on two glass surfaces

| TYPE | U-VALUE | R-VALUE | SOLAR HEAT GAIN NO/GRIDS | SOLAR HEAT GAIN W/GRIDS | VISIBLE LIGHT NO/GRIDS | VISIBLE LIGHT W/GRIDS | CONDENSATION RESISTANCE | U.S. ENERGY STAR ZONES NO/GRIDS | U.S. ENERGY STAR ZONES W/GRIDS | U.S. ZONES ENERGY STAR MOST EFFICIENT NO/GRIDS | U.S. ZONES ENERGY STAR MOST EFFICIENT W/GRIDS |
|-------------------------------|---------|---------|--------------------------|-------------------------|------------------------|-----------------------|-------------------------|---------------------------------|--------------------------------|--|---|
| CASEMENT | .18 | 5.56 | .24 | .22 | .38 | .35 | 71 | All | All | All | All |
| AWNING WINDOW | .18 | 5.56 | .24 | .22 | .38 | .35 | 71 | All | All | All | All |
| DIRECT-SET PICTURE WINDOW | .16 | 6.25 | .31 | .28 | .51 | .46 | 71 | N, NC | N, NC | N, NC | N, NC |
| FIXED CASEMENT PICTURE WINDOW | .17 | 5.88 | .28 | .25 | .45 | .40 | 70 | N, NC | All | N, NC | All |

Energy Guard Triple Insulated Glass (ENERGY STAR Most Efficient) Triple insulated glass with high-performance LoE™ 366/Argon on two glass surfaces

| TYPE | U-VALUE | R-VALUE | SOLAR HEAT GAIN NO/GRIDS | SOLAR HEAT GAIN W/GRIDS | VISIBLE LIGHT NO/GRIDS | VISIBLE LIGHT W/GRIDS | CONDENSATION RESISTANCE | U.S. ENERGY STAR ZONES NO/GRIDS | U.S. ENERGY STAR ZONES W/GRIDS | U.S. ZONES ENERGY STAR MOST EFFICIENT NO/GRIDS | U.S. ZONES ENERGY STAR MOST EFFICIENT W/GRIDS |
|-------------------------------|---------|---------|--------------------------|-------------------------|------------------------|-----------------------|-------------------------|---------------------------------|--------------------------------|--|---|
| CASEMENT | .18 | 5.56 | .16 | .15 | .31 | .28 | 72 | All | All | NC, SC, S | NC, SC, S |
| AWNING WINDOW | .18 | 5.56 | .16 | .15 | .31 | .28 | 71 | All | All | NC, SC, S | NC, SC, S |
| DIRECT-SET PICTURE WINDOW | .16 | 6.25 | .21 | .19 | .41 | .37 | 71 | All | All | All | NC, SC, S |
| FIXED CASEMENT PICTURE WINDOW | .16 | 6.25 | .19 | .17 | .36 | .33 | 71 | All | All | NC, SC, S | NC, SC, S |

ENERGY STAR® Compliance



Indicates ENERGY STAR® compliance for appropriate glazing zone. The ENERGY STAR program was developed by the U. S. Department of Energy and the Environmental Protection Agency to help consumers identify products that save energy. Requirements for windows are tailored to meet the energy needs of the country's four different regions - Northern, North/Central, South/Central and Southern. ENERGY STAR windows must be rated, certified and labeled by the National Fenestration Rating Council (NFRC) for U-Factor and Solar Heat Gain Coefficient (SHGC).

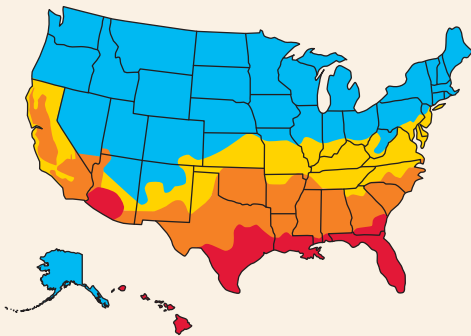

- Northern Mostly Heating
- South/Central Heating & Cooling
- North/Central Heating & Cooling
- Southern Mostly Cooling

*Doors meet ENERGY STAR at .30 U-Factor. SHGC may vary by zone.



| Zone | U-factor ¹ | SHGC ² |
|---------------|-----------------------|-------------------|
| Northern | ≤ 0.27 | Any |
| North/Central | ≤ 0.30 | ≤ 0.40 |
| South/Central | ≤ 0.30 | ≤ 0.25 |
| Southern | ≤ 0.40 | ≤ 0.25 |



| Zone | U-factor ¹ | SHGC ² |
|---------------|-----------------------|-------------------|
| Northern | ≤ 0.20 | ≥ 0.20 |
| North/Central | ≤ 0.20 | ≤ 0.40 |
| South/Central | ≤ 0.20 | ≤ 0.25 |
| Southern | ≤ 0.20 | ≤ 0.25 |

Help Protect The Environment. If all single pane residential windows in the United States were replaced with ENERGY STAR qualifying models, the nation would save over \$12 billion per year in energy costs.



An exceptional value, Thermo-Tech slider windows combine both performance and price appeal. Sliding windows are available in either 2-lite or 3-lite configurations (including equal lite and 1/4 - 1/2 - 1/4).

FEATURES AND BENEFITS

- Brass rollers ensure smooth and easy operation of the sash.
- Track lock system locks window sash in closed position or at 2" open for security and ventilation.
- Die cast lock and keeper for added security.
- Multi-layered weather stripping provides maximum resistance to air, water, and dust infiltration.
- Custom hardware upgrade to Antique Brass.
- Oak laminate windows come standard with Sandlewood hardware.
- See other options on pages 4-5.

HORIZONTAL SLIDERS - STANDARD SIZES

| WINDOW DIMENSIONS | | 2'-11 1/2" | 3'-11 1/2" | 4'-0 1/2" | 4'-11 1/2" | 5'-11 1/2" |
|-------------------|----------------|------------|------------|-----------|------------|------------|
| | WIDTH | | | | | |
| | ROUGH OPENINGS | 3'-0 1/4" | 4'-0 1/4" | 4'-1 1/4" | 5'-0 1/4" | 6'-0 1/4" |
| 1'-11 1/2" | 2'-0 1/4" | TS 3624 | TS 4824 | | TS 6024 | TS 7224 |
| | 2'-5 1/2" | | | | TS 6030 | |
| 2'-11 1/2" | 3'-0 1/4" | TS 3636 | TS 4836 | | TS 6036 E | TS 7236 E |
| 3'-5 1/2" | 3'-6 1/4" | TS 3642 | TS 4842 | | TS 6042 E | TS 7242 E |
| 3'-7 1/2" | 3'-8 1/4" | TS 3644 | TS 4844 | TS 4944 E | TS 6044 E | TS 7244 E |
| 3'-11 1/2" | 4'-0 1/4" | TS 3648 | TS 4848 E | | TS 6048 E | TS 7248 E |
| 4'-5 1/2" | 4'-6 1/4" | TS 3654 | TS 4854 E | | TS 6054 E | TS 7254 E |
| 4'-11 1/2" | 5'-0 1/4" | TS 3660 | TS 4860 E | | TS 6060 E | TS 7260 E |

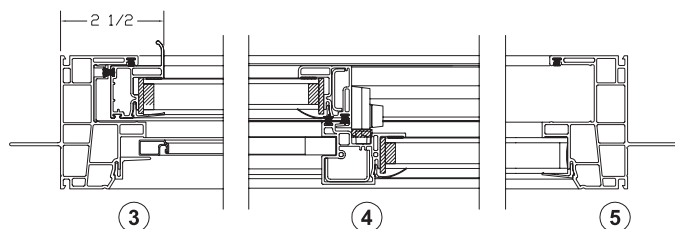
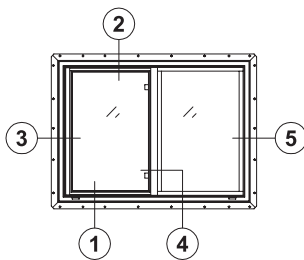
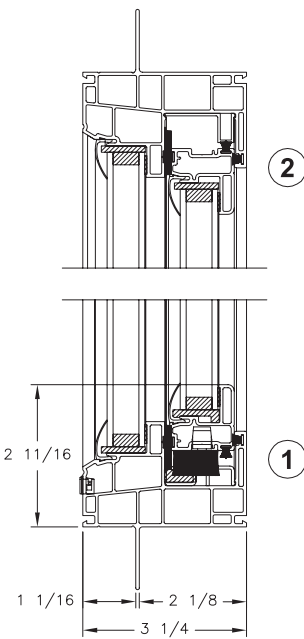

Shaded area denotes 5.7 sq. ft. opening or greater.
Specify XO or OX as viewed from the exterior (X=active panel).
NOTE: Verify local or state egress opening sizes with your local building inspector.

3 LITE SLIDERS - STANDARD SIZES

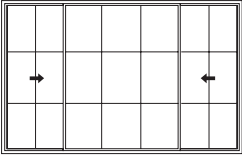
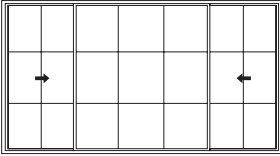
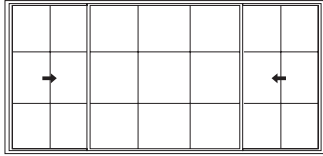
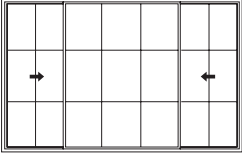
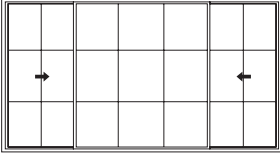
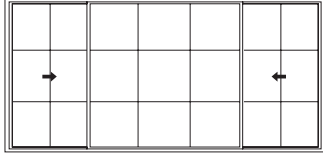
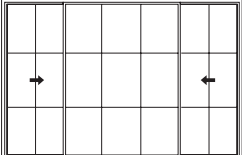
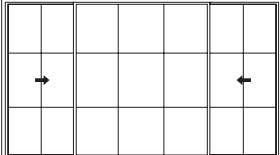
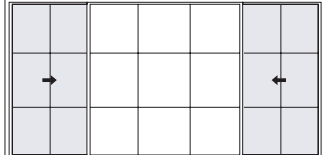
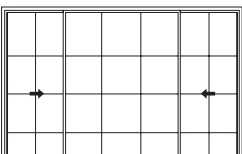
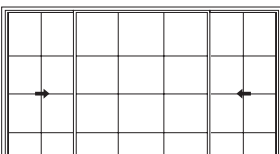
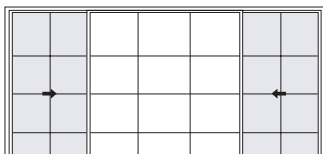
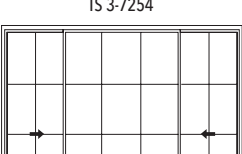
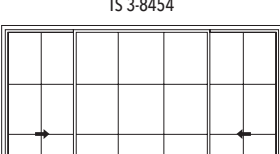
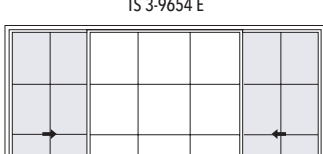
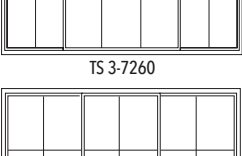
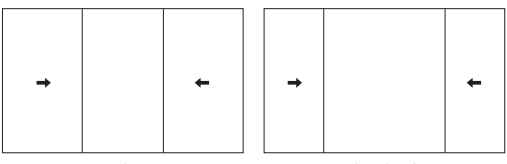
| WINDOW DIMENSIONS | | 5'-11 1/2" | 6'-11 1/2" | 7'-11 1/2" |
|-------------------|------------|--|---|---|
| WIDTH | | | | |
| ROUGH OPENINGS | | 6'-0 1/4" | 7'-0 1/4" | 8'-0 1/4" |
| HEIGHT | 3'-5 1/2" | 3'-6 1/4"  TS 3-7242 |  TS 3-8442 |  TS 3-9642 |
| | 3'-7 1/2" |  TS 3-7244 |  TS 3-8444 |  TS 3-9644 |
| | 3'-11 1/2" |  TS 3-7248 |  TS 3-8448 |  TS 3-9648 E |
| | 4'-5 1/2" |  TS 3-7254 |  TS 3-8454 |  TS 3-9654 E |
| | 4'-11 1/2" |  TS 3-7260 |  TS 3-8460 |  TS 3-9660 E |
| | 5'-11 1/2" |  TS 3-7272 (not available in 1/4 - 1/2 - 1/4) |  Equal Lite 1/4 - 1/2 - 1/4 All units available in equal lite or 1/4 - 1/2 - 1/4 unless otherwise noted. | |

Shaded windows denote 5.7 sq. ft. clear opening or greater.

NOTE: Verify local or state egress opening sizes with your local building inspector.

UTILITY UNITS - STANDARD SIZES

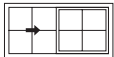
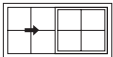
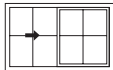
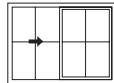
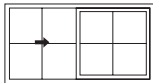
| WINDOW DIMENSIONS | 2'-7 1/2" w x 1'-2" h | 2'-7 1/2" w x 1'-3 1/4" h | 2'-7 1/2" w x 1'-7 1/4" h | 2'-7 1/2" w x 1'-11 1/4" h | 3'-7 3/4" w x 1'-11 1/4" h |
|-------------------|--|--|--|--|--|
| ROUGH OPENINGS | 2'-8 1/4" w x 1'-2 3/4" h | 2'-8 1/4" w x 1'-4" h | 2'-8 1/4" w x 1'-8" h | 2'-8 1/4" w x 2'-0" h | 3'-8 1/2" w x 2'-0" h |
| |  TS 3214 |  TS 3216 |  TS 3220 |  TS 3224 |  TS 4424 |



Precisely engineered, Thermo-Tech casement window systems ensure a tight, energy-efficient seal from top to bottom using multi-point locks. Plus, they foil break-ins better than single lock window systems. Our smooth-operating hinges open to a full 90° for easy cleaning from the inside. Design options are endless. Use them individually. Align them for a classic look. Or stack a fixed transom or half circle above two casement windows to create a contemporary style.

FEATURES AND BENEFITS

- Multi-point locking hardware secures sash tightly with a single lever.
- Easy cleaning from the inside with the exception of windows with egress hardware.
- Triple-layered weather stripping.
- Heavy-duty standard low-profile folding hardware.
- All hardware comes color matched to the interior window color.
- Two additional custom hardware colors available: Oil-Rubbed Bronze and Antique Brass.
- Oak laminate windows come standard with Sandlewood hardware.
- See other options on pages 4-5.



Also available as **Thermo-Tech® ENERGY GUARD & ENERGY GUARD PLUS Triple glass options.**

See page 7 for performance data. Available in sizes noted with an "**".













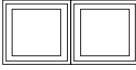
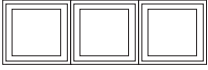
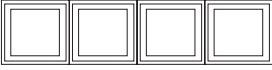
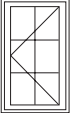
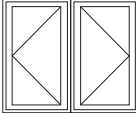
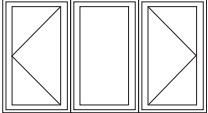

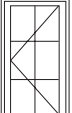
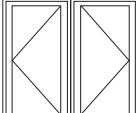
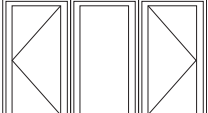

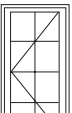
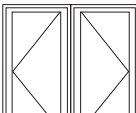
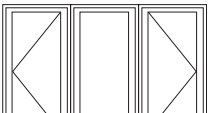
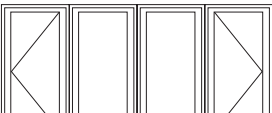
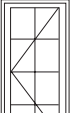
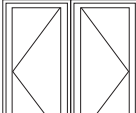
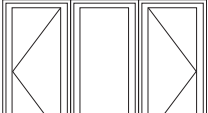

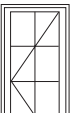
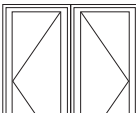
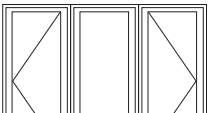
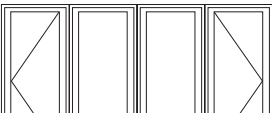
Low-profile folding hardware

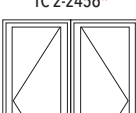
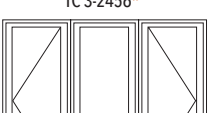
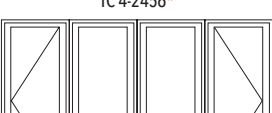
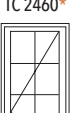
NOTE: Verify local or state egress opening sizes with your local building inspector. Please specify egress hardware when ordering.

CASEMENT WINDOWS - STANDARD SIZES

| WINDOW DIMENSIONS | | 1'-7 1/2" | 3'-3 1/8" | 4'-10 3/4" | 6'-6 3/8" |
|-------------------|---------------|------------------------|-------------|-------------|-------------|
| WIDTH | | | | | |
| ROUGH OPENINGS | | 1' 8 1/4" | 3'-3 7/8" | 4'-11 1/2" | 6'-7 1/8" |
| HEIGHT | Fixed Transom | | | | |
| | 1'-5 1/2" | 1'-6 1/4" TFC 2018* | TFC 2-2018* | TFC 3-2018* | TFC 4-2018* |
| | 2'-11 1/2" | TC 2036* | TC 2-2036* | TC 3-2036* | TC 4-2036* |
| | 3'-5 1/2" | TC 2042* | TC 2-2042* | TC 3-2042* | TC 4-2042* |
| | 3'-11 1/2" | TC 2048* | TC 2-2048* | TC 3-2048* | TC 4-2048* |
| | 4'-3 1/2" | TC 2052* | TC 2-2052* | TC 3-2052* | TC 4-2052* |
| | 4'-7 1/2" | TC 2056* | TC 2-2056* | TC 3-2056* | TC 4-2056* |
| | 4'-11 1/2" | TC 2060* | TC 2-2060* | TC 3-2060* | TC 4-2060* |
| | 5'-3 1/2" | TC 2064* | TC 2-2064* | TC 3-2064* | TC 4-2064* |
| | 5'-11 1/2" | TC 2072* | TC 2-2072* | TC 3-2072* | TC 4-2072* |

CASEMENT WINDOWS - STANDARD SIZES

| WINDOW DIMENSIONS | | 1'-11 1/2" | 3'-11 1/8" | 5'-10 3/4" | 7'-10 3/8" | |
|-------------------|---------------|---|---|---|--|--|
| WIDTH | | | | | | |
| ROUGH OPENINGS | | 2'-0 1/4" | 3'-11 7/8" | 5'-11 1/2" | 7'-11 1/8" | |
| HEIGHT | Fixed Transom | | | | | |
| | 1'-5 1/2" | 1'-6 1/4" |  |  |  |  |
| | | | TFC 2418* | TFC 2-2418* | TFC 3-2418* | TFC 4-2418* |
| | 2'-11 1/2" | 3'-0 1/4" |  |  |  |  |
| | | | TC 2436* | TC 2-2436* | TC 3-2436* | TC 4-2436* |
| | 3'-5 1/2" | 3'-6 1/4" |  |  |  |  |
| | | | TC 2442* | TC 2-2442* | TC 3-2442* | TC 4-2442* |
| | 3'-11 1/2" | 4'-0 1/4" |  |  |  |  |
| | | | TC 2448* | TC 2-2448* | TC 3-2448* | TC 4-2448* |
| | 4'-3 1/2" | 4'-4 1/4" |  |  |  |  |
| | | | TC 2452* | TC 2-2452* | TC 3-2452* | TC 4-2452* |
| | 4'-7 1/2" | 4'-8 1/4" |  |  |  |  |
| | | | TC 2456* | TC 2-2456* | TC 3-2456* | TC 4-2456* |
| | 4'-11 1/2" | 5'-0 1/4" |  |  |  |  |
| | | TC 2460* | TC 2-2460* | TC 3-2460* | TC 4-2460* | |
| 5'-3 1/2" | 5'-4 1/4" |  |  |  |  | |
| | | TC 2464* | TC 2-2464* | TC 3-2464* | TC 4-2464* | |
| 5'-11 1/2" | 6'-0 1/4" |  |  |  |  | |
| | | TC 2472* | TC 2-2472* | TC 3-2472* | TC 4-2472* | |



Also available as
Thermo-Tech®
ENERGY GUARD®
ENERGY GUARD PLUS
Triple glass options.

See page 7 for performance data.
 Available in sizes noted with an "*".

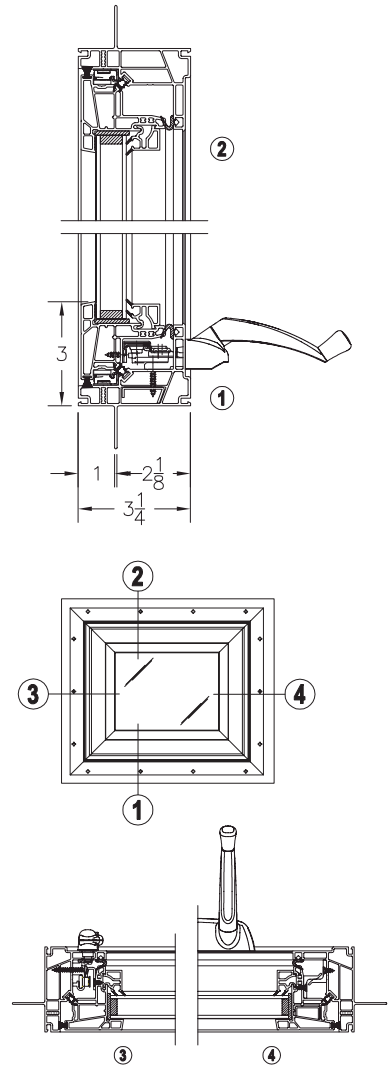

NOTE: Verify local or state egress opening sizes with your local building inspector.
 Please specify egress hardware when ordering.



Shaded windows denote 5.7 sq. ft. clear opening or greater when configured with egress hardware.

NOTE: Verify local or state egress opening sizes with your local building inspector.

Please specify egress hardware when ordering.













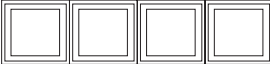

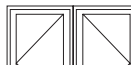











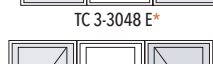



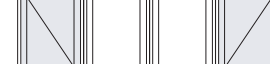

Also available as Thermo-Tech® ENERGY GUARD & ENERGY GUARD PLUS Triple glass options.

See page 7 for performance data. Available in sizes noted with an "*".

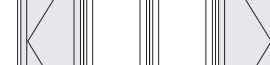

| WINDOW DIMENSIONS | | 2'-3 1/2" | 4'-7 1/8" | 6'-10 3/4" | 9'-2 3/8" |
|-------------------|----------------|---------------|--------------|--------------|--------------|
| | WIDTH | | | | |
| | ROUGH OPENINGS | 2'-4 1/4" | 4'-7 7/8" | 6'-11 1/2" | 9'-3 1/8" |
| | HEIGHT | Fixed Transom | | | |
| 1'-5 1/2" | 1'-6 1/4" | TC 2818* | TFC 2-2818* | TFC 3-2818* | TFC 4-2818* |
| 2'-11 1/2" | 3'-0 1/4" | TC 2836* | TC 2-2836* | TC 3-2836* | TC 4-2836* |
| 3'-5 1/2" | 3'-6 1/4" | TC 2842* | TC 2-2842* | TC 3-2842* | TC 4-2842* |
| 3'-11 1/2" | 4'-0 1/4" | TC 2848 E* | TC 2-2848 E* | TC 3-2848 E* | TC 4-2848 E* |
| 4'-3 1/2" | 4'-4 1/4" | TC 2852 E* | TC 2-2852 E* | TC 3-2852 E* | TC 4-2852 E* |
| 4'-7 1/2" | 4'-8 1/4" | TC 2856 E* | TC 2-2856 E* | TC 3-2856 E* | TC 4-2856 E* |
| 4'-11 1/2" | 5'-0 1/4" | TC 2860 E* | TC 2-2860 E* | TC 3-2860 E* | TC 4-2860 E* |
| 5'-3 1/2" | 5'-4 1/4" | TC 2864 E | TC 2-2864 E | TC 3-2864 E | TC 4-2864 E |
| 5'-11 1/2" | 6'-0 1/4" | TC 2872 E | TC 2-2872 E | TC 3-2872 E | TC 4-2872 E |

CASEMENT WINDOWS - STANDARD SIZES

| WINDOW DIMENSIONS | | 2'-5 1/2" | 4'-11 1/8" | 7'-4 3/4" | 9'-10 3/8" | |
|-------------------|---------------|---|---|---|--|--|
| WIDTH | | | | | | |
| ROUGH OPENINGS | | 2'-6 1/4" | 4'-11 7/8" | 7'-5 1/2" | 9'-11 1/8" | |
| HEIGHT | Fixed Transom | | | | | |
| | 1'-5 1/2" | 1'-6 1/4" |  |  |  |  |
| | | | TFC 3018 | TFC 2-3018 | TFC 3-3018 | TFC 4-3018 |
| | 2'-11 1/2" | 3'-0 1/4" |  |  |  |  |
| | | | TC 3036* | TC 2-3036* | TC 3-3036* | TC 4-3036* |
| | 3'-5 1/2" | 3'-6 1/4" |  |  |  |  |
| | | | TC 3042* | TC 2-3042* | TC 3-3042* | TC 4-3042* |
| | 3'-11 1/2" | 4'-0 1/4" |  |  |  |  |
| | | | TC 3048 E* | TC 2-3048 E* | TC 3-3048 E* | TC 4-3048 E* |
| | 4'-3 1/2" | 4'-4 1/4" |  |  |  |  |
| | | | TC 3052 E* | TC 2-3052 E* | TC 3-3052 E* | TC 4-3052 E* |
| 4'-7 1/2" | 4'-8 1/4" |  |  |  |  | |
| | | TC 3056 E* | TC 2-3056 E* | TC 3-3056 E* | TC 4-3056 E* | |
| 4'-11 1/2" | 5'-0 1/4" |  |  |  |  | |
| | | TC 3060 E* | TC 2-3060 E* | TC 3-3060 E* | TC 4-3060 E* | |
| 5'-3 1/2" | 5'-4 1/4" |  |  |  |  | |
| | | TC 3064 E | TC 2-3064 E | TC 3-3064 E | TC 4-3064 E | |
| 5'-11 1/2" | 6'-0 1/4" |  |  |  |  | |
| | | TC 3072 E | TC 2-3072 E | TC 3-3072 E | TC 4-3072 E | |

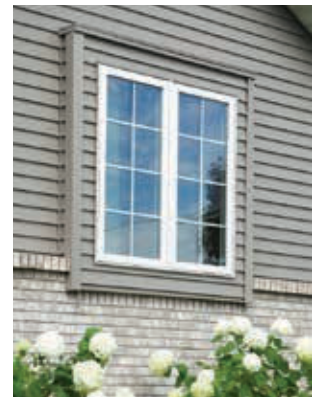

Shaded windows denote 5.7 sq. ft. clear opening or greater when configured with egress hardware.

NOTE: Verify local or state egress opening sizes with your local building inspector.

Please specify egress hardware when ordering.

Also available as
Thermo-Tech®
ENERGY GUARD &
ENERGY GUARD PLUS
Triple glass options.

See page 7 for performance data.
 Available in sizes noted with an "*".



Shaded windows denote 5.7 sq. ft. clear opening or greater when configured with egress hardware.

NOTE: Verify local or state egress opening sizes with your local building inspector.

Please specify egress hardware when ordering.

Also available as **Thermo-Tech® ENERGY GUARD & ENERGY GUARD PLUS Triple glass options.**

See page 7 for performance data. Available in sizes noted with an "*" or "**".

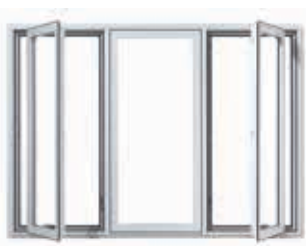

| WINDOW DIMENSIONS | | CASEMENT WINDOWS - STANDARD SIZES | | | |
|-------------------|---------------|-----------------------------------|--------------|--------------|--------------|
| | | WIDTH | | | |
| ROUGH OPENINGS | | 2'-7 1/2" | 5'-3 1/8" | 7'-10 3/4" | 10'-6 3/8" |
| HEIGHT | Fixed Transom | | | | |
| | 1'-5 1/2" | 1'-6 1/4" | TFC 3218* | TFC 2-3218* | TFC 3-3218* |
| 2'-11 1/2" | 3'-0 1/4" | TC 3236* | TC 2-3236* | TC 3-3236* | TC 4-3236* |
| 3'-5 1/2" | 3'-6 1/4" | TC 3242 E* | TC 2-3242 E* | TC 3-3242 E* | TC 4-3242 E* |
| 3'-11 1/2" | 4'-0 1/4" | TC 3248 E* | TC 2-3248 E* | TC 3-3248 E* | TC 4-3248 E* |
| 4'-3 1/2" | 4'-4 1/4" | TC 3252 E* | TC 2-3252 E* | TC 3-3252 E* | TC 4-3252 E* |
| 4'-7 1/2" | 4'-8 1/4" | TC 3256 E* | TC 2-3256 E* | TC 3-3256 E* | TC 4-3256 E* |
| 4'-11 1/2" | 5'-0 1/4" | TC 3260 E* | TC 2-3260 E* | TC 3-3260 E* | TC 4-3260 E* |
| 5'-3 1/2" | 5'-4 1/4" | TC 3264 E | TC 2-3264 E | TC 3-3264 E | TC 4-3264 E |
| 5'-11 1/2" | 6'-0 1/4" | TC 3272 E | TC 2-3272 E | TC 3-3272 E | TC 4-3272 E |

Window Opening Control Devices (WOCDs)



Slider



Casement



Single-Hung and Double-Hung

At Thermo-Tech we are committed to the safety of our customers, and the performance of our products. That's why we test to all applicable ASTM standards for the window and door industry. The American Society for Testing and Materials (ASTM), has set over 12,000 product standards globally to help give consumers confidence in the products they buy and use.

Our Window Opening Control Devices (WOCDs) meet the ASTM F 2090-10 code for fall prevention of small children through window openings. To meet this standard, devices must limit the opening of a window to 4" unless disengaged by two separate physical actions. Once closed, these devices must also reengage automatically.

WOCD options are available from Thermo-Tech on double hungs, single hungs, sliders, and casements. Before ordering, please verify state and local building codes for window locations where these devices may be required.



CASEMENT WINDOWS - STANDARD SIZES



Shaded windows denote 5.7 sq. ft. clear opening or greater when configured with egress hardware.

NOTE: Verify local or state egress opening sizes with your local building inspector.

Please specify egress hardware when ordering.

Also available as Thermo-Tech® ENERGY GUARD & ENERGY GUARD PLUS Triple glass options.

See page 7 for performance data. Available in sizes noted with an "*".









| WINDOW DIMENSIONS | | 2'-11 1/2" | 5'-11 1/8" | 8'-10 3/4" | 11'-10 3/8" | |
|-------------------|------------|------------|---------------|--------------|--------------|--------------|
| WIDTH | | | | | | |
| ROUGH OPENINGS | | 3'-0 1/4" | 5'-11 7/8" | 8'-11 1/2" | 11'-11 1/2" | |
| HEIGHT | 1'-5 1/2" | 1'-6 1/4" | Fixed Transom | | | |
| | | | | | | |
| | | | TFC 3618* | TFC 2-3618* | TFC 3-3618* | TFC 4-3618* |
| | 2'-11 1/2" | 3'-0 1/4" | | | | |
| | | | TC 3636* | TC 2-3636* | TC 3-3636* | TC 4-3636* |
| | 3'-5 1/2" | 3'-6 1/4" | | | | |
| | | | TC 3642 E* | TC 2-3642 E* | TC 3-3642 E* | TC 4-3642 E* |
| | 3'-7 1/2" | 3'-8 1/4" | | | | |
| | | | TC 3644 E* | TC 2-3644 E* | TC 3-3644 E* | TC 4-3644 E* |
| | 3'-11 1/2" | 4'-0 1/4" | | | | |
| | | | TC 3648 E* | TC 2-3648 E* | TC 3-3648 E* | TC 4-3648 E* |
| | 4'-3 1/2" | 4'-4 1/4" | | | | |
| | | | TC 3652 E* | TC 2-3652 E* | TC 3-3652 E* | TC 4-3652 E* |
| 4'-7 1/2" | 4'-8 1/4" | | | | | |
| | | TC 3656 E* | TC 2-3656 E* | TC 3-3656 E* | TC 4-3656 E* | |
| 4'-11 1/2" | 5'-0 1/4" | | | | | |
| | | TC 3660 E* | TC 2-3660 E* | TC 3-3660 E* | TC 4-3660 E* | |
| 5'-3 1/2" | 5'-4 1/4" | | | | | |
| | | TC 3664 E | TC 2-3664 E | TC 3-3664 E | TC 4-3664 E | |
| 5'-11 1/2" | 6'-0 1/4" | | | | | |
| | | TC 3672 E | TC 2-3672 E | TC 3-3672 E | TC 4-3672 E | |

Thermo-Tech fixed casement and direct-set window systems invite creative applications for your construction projects. Use fixed casements for simple picture windows or in multiple casement window units. Mulling them together creates a variety of combinations. Direct-set picture windows, our most versatile stationary option, can

stand alone or adjoin double-hung, single-hung or slider windows in impressive multiple-wide units. Transoms above them add an elegant touch. Direct-set windows follow the same standard sizes as fixed casements.

See other options on pages 4-5.

Also available as
Thermo-Tech®
ENERGY GUARD &
ENERGY GUARD PLUS
 Triple glass options.
 See page 7 for performance data.
 Available in sizes noted with an "*".

| FIXED CASEMENT & DIRECT-SET WINDOWS | | | | | | | | | | | | |
|-------------------------------------|----------------|---|---|---|---|---|---|---|---|---|--|---|
| WINDOW DIMENSIONS | 1'-7 1/2" | 1'-11 1/2" | 2'-3 1/2" | 2'-5 1/2" | 2'-7 1/2" | 2'-11 1/2" | 3'-3 1/2" | 3'-7 1/2" | 3'-11 1/2" | 4'-3 1/2" | 4'-7 1/2" | |
| | WIDTH | | | | | | | | | | | |
| | ROUGH OPENINGS | | | | | | | | | | | |
| HEIGHT | 1'-8 1/4" | 2'-0 1/4" | 2'-4 1/4" | 2'-6 1/4" | 2'-8 1/4" | 3'-0 1/4" | 3'-4 1/4" | 3'-8 1/4" | 4'-0 1/4" | 4'-4 1/4" | 4'-8 1/4" | |
| 1'-11 1/2" | 2'-0 1/4" |  2024* |  2424* |  2824* |  3024* |  3224* |  3624* |  4024* |  4424* |  4824* |  5224* |  5624* |
| 2'-11 1/2" | 3'-0 1/4" |  2036* |  2436* |  2836* |  3036* |  3236* |  3636* |  4036* |  4436* |  4836* |  5236* |  5636* |
| 3'-3 1/2" | 3'-4 1/4" |  2040* |  2440* |  2840* |  3040* |  3240* |  3640* |  4040* |  4440* |  4840* |  5240* |  5640* |
| 3'-5 1/2" | 3'-6 1/4" |  2042* |  2442* |  2842* |  3042* |  3242* |  3642* |  4042* |  4442* |  4842* |  5242* |  5642* |
| 3'-11 1/2" | 4'-0 1/4" |  2048* |  2448* |  2848* |  3048* |  3248* |  3648* |  4048* |  4448* |  4848* |  5248* |  5648* |
| 4'-3 1/2" | 4'-4 1/4" |  2052* |  2452* |  2852* |  3052* |  3252* |  3652* |  4052* |  4452* |  4852* |  5252* |  5652* |
| 4'-7 1/2" | 4'-8 1/4" |  2056* |  2456* |  2856* |  3056* |  3256* |  3656* |  4056* |  4456* |  4856* |  5256* |  5656* |
| 4'-11 1/2" | 5'-0 1/4" |  2060* |  2460* |  2860* |  3060* |  3260* |  3660* |  4060* |  4460* |  4860* |  5260* |  5660* |
| 5'-3 1/2" | 5'-4 1/4" |  2064* |  2464* |  2864* |  3064* |  3264* |  3664* |  4064* |  4464* |  4864* |  5264* |  5664* |
| 5'-11 1/2" | 6'-0 1/4" |  2072* |  2472* |  2872* |  3072* |  3272* |  3672* |  4072* |  4472* |  4872* |  5272* |  5672* |

NOTE: Grids shown reflect direct-set patterns. Fixed casement grid patterns match casement windows.



| FIXED CASEMENT & DIRECT-SET WINDOWS | | | | | | | |
|-------------------------------------|------------|-----------|-----------|------------|------------|------------|-------|
| WINDOW DIMENSIONS | 4'-11 1/2" | 5'-3 1/2" | 5-7 1/2" | 5'-11 1/2" | 6'-11 1/2" | 7'-11 1/2" | |
| | WIDTH | | | | | | |
| ROUGH OPENINGS | 5'-0 1/4" | 5'-4 1/4" | 5'-8 1/4" | 6'-0 1/4" | 7'-0 1/4" | 8'-0 1/4" | |
| 2'-11 1/2" | 3'-0 1/4" | 6036* | 6436* | 6836* | 7236* | 8436* | 9636* |
| | 3'-3 1/2" | 6040* | 6440* | 6840* | 7240* | 8440* | 9640* |
| 3'-5 1/2" | 3'-6 1/4" | 6042* | 6442* | 6842* | 7242* | 8442* | 9642* |
| | 3'-11 1/2" | 6048* | 6448* | 6848* | 7248* | 8448* | 9648* |
| 4'-3 1/2" | 4'-4 1/4" | 6052* | 6452* | 6852* | 7252* | 8452* | 9652* |
| | 4'-7 1/2" | 6056* | 6456* | 6856* | 7256* | 8456* | 9656* |
| 4'-11 1/2" | 5'-0 1/4" | 6060* | 6460* | 6860* | 7260* | 8460* | 9660 |
| | 5'-3 1/2" | 6064* | 6464* | 6864* | 7264* | 8464 | |
| 5'-11 1/2" | 6'-0 1/4" | 6072* | 6472* | 6872* | 7272 | 8472 | |

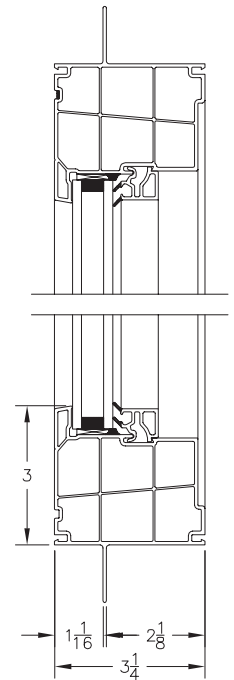

Fixed Casement

NOTE: Grids shown reflect direct-set patterns. Fixed casement grid patterns match casement windows.

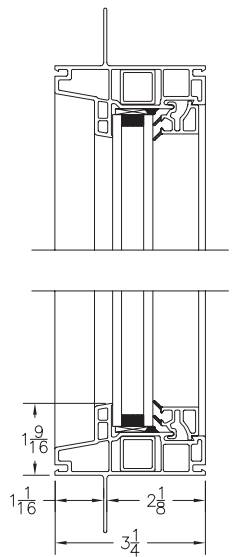

Direct-Set



Also available as
Thermo-Tech®
ENERGY GUARD &
ENERGY GUARD PLUS
Triple glass options.
 See page 7 for performance data.
 Available in sizes noted with an "*".

Thermo-Tech awning window systems use two locking handles for a tight, energy-efficient seal from top to bottom. They also resist break-ins better than single-lock window systems. Awning windows complement classic styles when used alone or placed next to each other. Stack a fixed transom or half round above awning windows for a more dramatic effect.





FEATURES AND BENEFITS

- Two locking handles for added security.
 - Triple layered weather stripping.
 - Heavy-duty standard low-profile folding hardware.
 - All hardware is color matched to the interior window color.
 - Scissor type hardware for smooth operation and tight weather seal.
- Oak laminate windows come standard with Sandlewood hardware.
 - See other options on pages 4-5.

Also available as **Thermo-Tech® ENERGY GUARD & ENERGY GUARD PLUS Triple glass options.**

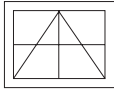
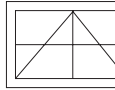
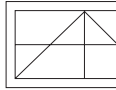
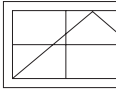
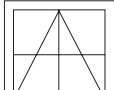
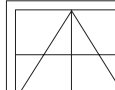
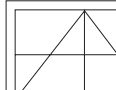
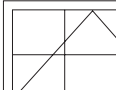
See page 7 for performance data. Available in sizes noted with an "*".

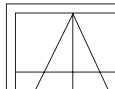
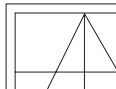

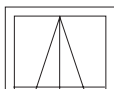
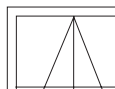
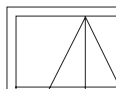
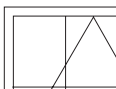
| 2600 AWNING WINDOWS - STANDARD SIZES | | | | | |
|--------------------------------------|------------|---|--|---|---|
| WINDOW DIMENSIONS | | 1'-7 1/2" | 1'-11 1/2" | 2'-3 1/2" | 2'-7 1/2" |
| | | WIDTH | | | |
| ROUGH OPENINGS | | 1'-8 1/4" | 2'-0 1/4" | 2'-4 1/4" | 2'-8 1/4" |
| HEIGHT | 1'-3 1/2" |  TA 2016* |  TA 2416* |  TA 2816* |  TA 3216* |
| | 1'-7 1/2" |  TA 2020* |  TA 2420* |  TA 2820* |  TA 3220* |
| | 1'-11 1/2" |  TA 2024* |  TA 2424* |  TA 2824* |  TA 3224* |
| | 2'-3 1/2" |  TA 2028* |  TA 2428* |  TA 2828* |  TA 3228* |

COMBINATIONS USING AWNING UNITS

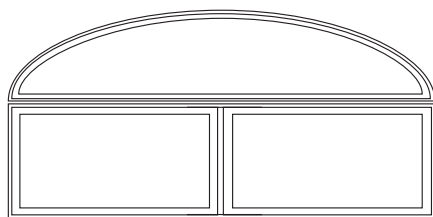

Fixed or venting awning windows

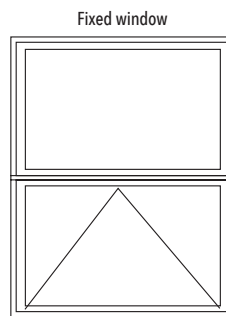

Venting awning window

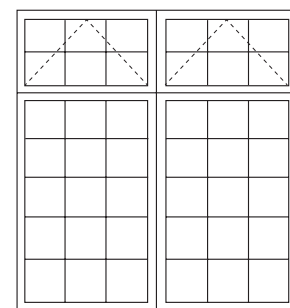

Awning window units stacked over fixed window units

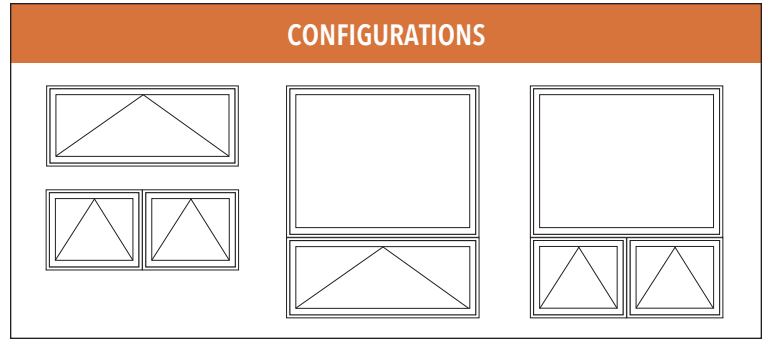

2600 AWNING WINDOWS - STANDARD SIZES

| | | | |
|------------|-----------|-----------|------------|
| 2'-11 1/2" | 3'-3 1/2" | 3'-7 1/2" | 3'-11 1/2" |
| 3'-0 1/4" | 3'-4 1/4" | 3'-8 1/4" | 4'-0 1/4" |

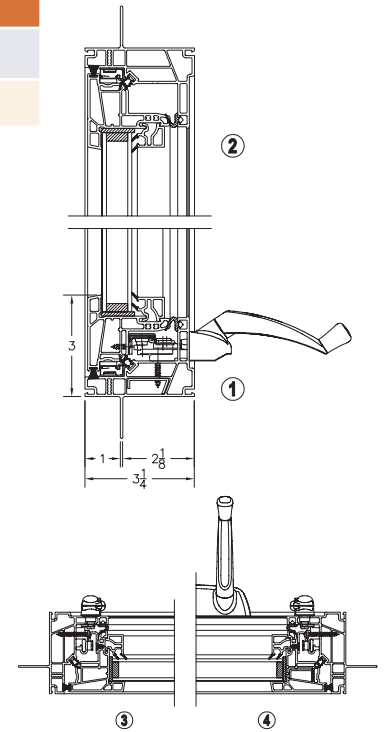
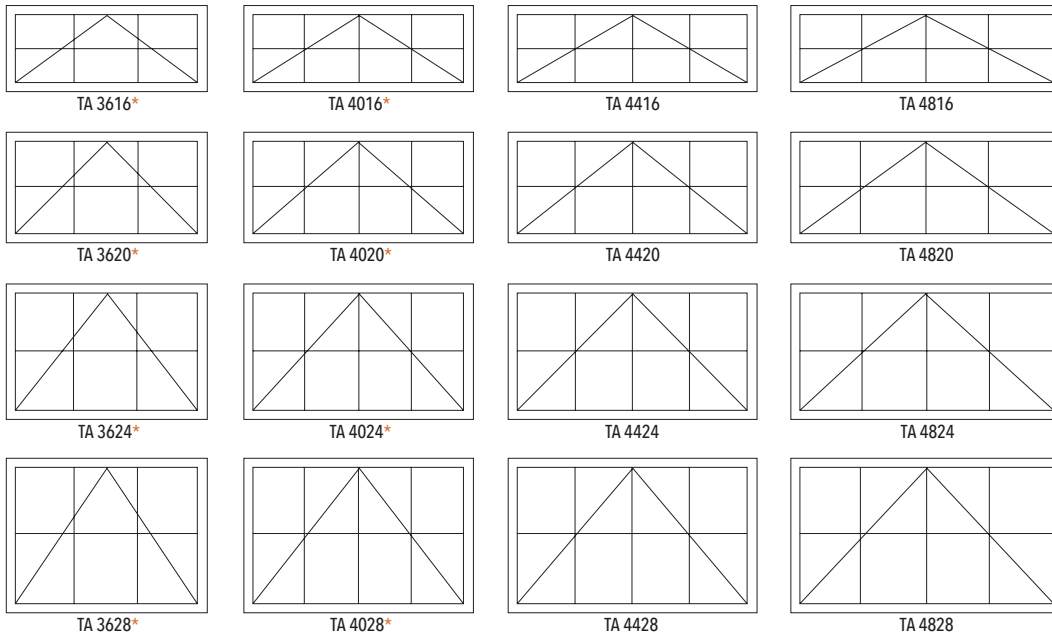

COMBINATIONS USING AWNING UNITS

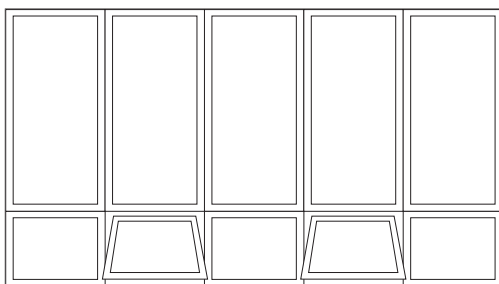

Fixed window units stacked over fixed and venting awnings

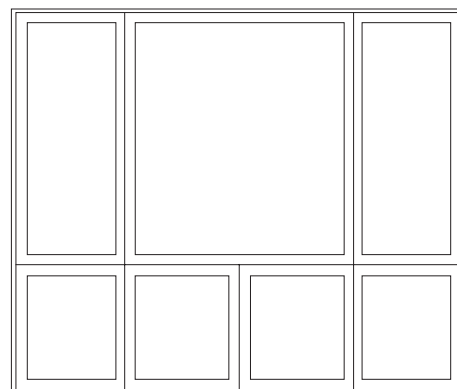

Fixed or venting casement windows stacked over fixed and/or venting awning windows



Thermo-Tech double-hung windows combine classic styling with our outstanding performance technology. We also engineer our double-hung windows to include standard features that most companies leave out. The result? Beautiful energy-efficient windows ready to enhance new homes.

FEATURES AND BENEFITS

- Top and bottom sashes tilt in for ease of cleaning.
- Flush mounted tilt latches.
- Smooth gliding balance system uses constant force coil that needs no adjusting and little maintenance.
- Die-cast lock and keeper hardware draws in the sash for secure and weather tight locking.
- Sloped sill directs water runoff.
- Dual weather-stripped interlocks at the meeting rail and double layered weather-stripping on the sashes maximize resistance to air, water and dust infiltration.
- Two additional custom hardware colors available: Oil-Rubbed Bronze and Antique Brass.
- Oak laminate windows come standard with Sandlewood hardware.
- See other options on pages 4-5.

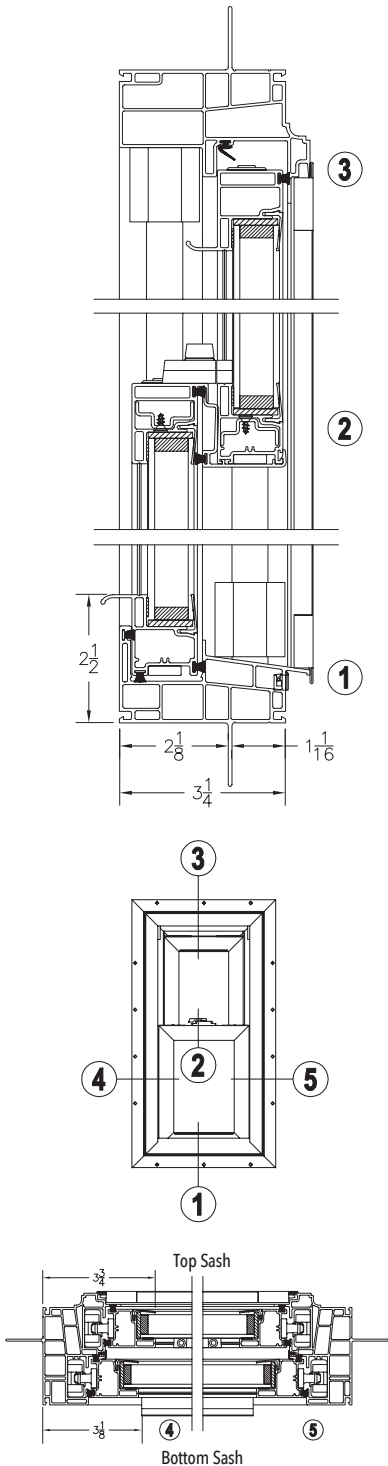

DOUBLE-HUNG WINDOWS - STANDARD SIZES

| WINDOW DIMENSIONS | | 1'-7 1/2" | 1'-11 1/2" | 2'-3 1/2" | 2'-5 1/2" | 2'-7 1/2" | 2'-11 1/2" | 3'-3 1/2" | 3'-7 1/2" | 3'-11 1/2" |
|-------------------|--------|-----------|------------|-----------|-----------|-----------|------------|-----------|-----------|------------|
| | | WIDTH | | | | | | | | |
| ROUGH OPENINGS | | 1'-8 1/4" | 2'-0 1/4" | 2'-4 1/4" | 2'-6 1/4" | 2'-8 1/4" | 3'-0 1/4" | 3'-4 1/4" | 3'-8 1/4" | 4'-0 1/4" |
| 2'-11 1/2" | HEIGHT | 3'-0 1/4" | 3'-0 1/4" | 3'-0 1/4" | 3'-0 1/4" | 3'-0 1/4" | 3'-0 1/4" | 3'-0 1/4" | 3'-0 1/4" | 3'-0 1/4" |
| | TDH | 2036 | 2436 | 2836 | 3036 | 3236 | 3636 | 4036 | 4436 | 4836 |
| 3'-3 1/2" | HEIGHT | 3'-4 1/4" | 3'-4 1/4" | 3'-4 1/4" | 3'-4 1/4" | 3'-4 1/4" | 3'-4 1/4" | 3'-4 1/4" | 3'-4 1/4" | 3'-4 1/4" |
| | TDH | 2040 | 2440 | 2840 | 3040 | 3240 | 3640 | 4040 | 4440 | 4840 |
| 3'-5 1/2" | HEIGHT | 3'-6 1/4" | 3'-6 1/4" | 3'-6 1/4" | 3'-6 1/4" | 3'-6 1/4" | 3'-6 1/4" | 3'-6 1/4" | 3'-6 1/4" | 3'-6 1/4" |
| | TDH | 2042 | 2442 | 2842 | 3042 | 3242 | 3642 | 4042 | 4442 | 4842 |
| 3'-11 1/2" | HEIGHT | 4'-0 1/4" | 4'-0 1/4" | 4'-0 1/4" | 4'-0 1/4" | 4'-0 1/4" | 4'-0 1/4" | 4'-0 1/4" | 4'-0 1/4" | 4'-0 1/4" |
| | TDH | 2048 | 2448 | 2848 | 3048 | 3248 | 3648 | 4048 | 4448 | 4848 |
| 4'-3 1/2" | HEIGHT | 4'-4 1/4" | 4'-4 1/4" | 4'-4 1/4" | 4'-4 1/4" | 4'-4 1/4" | 4'-4 1/4" | 4'-4 1/4" | 4'-4 1/4" | 4'-4 1/4" |
| | TDH | 2052 | 2452 | 2852 | 3052 | 3252 | 3652 | 4052 | 4452 | 4852 |
| 4'-7 1/2" | HEIGHT | 4'-8 1/4" | 4'-8 1/4" | 4'-8 1/4" | 4'-8 1/4" | 4'-8 1/4" | 4'-8 1/4" | 4'-8 1/4" | 4'-8 1/4" | 4'-8 1/4" |
| | TDH | 2056 | 2456 | 2856 | 3056 | 3256 | 3656 | 4056 | 4456 | 4856 |
| 4'-11 1/2" | HEIGHT | 5'-0 1/4" | 5'-0 1/4" | 5'-0 1/4" | 5'-0 1/4" | 5'-0 1/4" | 5'-0 1/4" | 5'-0 1/4" | 5'-0 1/4" | 5'-0 1/4" |
| | TDH | 2060 | 2460 | 2860 | 3060 | 3260 | 3660 | 4060 E | 4460 E | 4860 E |
| 5'-3 1/2" | HEIGHT | 5'-4 1/4" | 5'-4 1/4" | 5'-4 1/4" | 5'-4 1/4" | 5'-4 1/4" | 5'-4 1/4" | 5'-4 1/4" | 5'-4 1/4" | 5'-4 1/4" |
| | TDH | 2064 | 2464 | 2864 | 3064 | 3264 | 3664 | 4064 E | 4464 E | 4864 E |
| 5'-4 1/2" | HEIGHT | 5'-5 1/4" | 5'-5 1/4" | 5'-5 1/4" | 5'-5 1/4" | 5'-5 1/4" | 5'-5 1/4" | 5'-5 1/4" | 5'-5 1/4" | 5'-5 1/4" |
| | TDH | 2065 | 2465 | 2865 | 3065 | 3265 | 3665 | 4065 E | 4465 E | 4865 E |
| 5'-11 1/2" | HEIGHT | 6'-0 1/4" | 6'-0 1/4" | 6'-0 1/4" | 6'-0 1/4" | 6'-0 1/4" | 6'-0 1/4" | 6'-0 1/4" | 6'-0 1/4" | 6'-0 1/4" |
| | TDH | 2072 | 2472 | 2872 | 3072 | 3272 | 3672 E | 4072 E | | |

Classic style, exceptional performance and appealing price make the Thermo-Tech single-hung window one of our best values. Install single-hung windows side by side to beautifully complement a variety of multiple-window configurations.

FEATURES AND BENEFITS

- Flush mounted tilt latches.
- Single-Hung top glass is fixed into main frame and bottom sash tilts.
- Smooth gliding balance system uses constant force coil that needs no adjusting and little maintenance.
- Die-cast lock and keeper hardware draws in the sash for secure and weather tight locking.
- Sloped sill directs water runoff.
- Custom hardware upgrade to Antique Brass.
- Dual weather-stripped interlocks at the meeting rail and double layered weather-stripping on the sash maximize resistance to air, water and dust infiltration.
- See other options on pages 4-5.

SINGLE-HUNG WINDOWS - STANDARD SIZES

| WINDOW DIMENSIONS | | 1'-7 1/2" | 1'-11 1/2" | 2'-3 1/2" | 2'-5 1/2" | 2'-7 1/2" | 2'-11 1/2" | 3'-3 1/2" | 3'-7 1/2" | 3'-11 1/2" |
|-------------------|-----------|-----------|------------|-----------|-----------|-----------|------------|-----------|-----------|------------|
| WIDTH | | | | | | | | | | |
| ROUGH OPENINGS | | 1'-8 1/4" | 2'-0 1/4" | 2'-4 1/4" | 2'-6 1/4" | 2'-8 1/4" | 3'-0 1/4" | 3'-4 1/4" | 3'-8 1/4" | 4'-0 1/4" |
| 2'-11 1/2" | 3'-0 1/4" | | | | | | | | | |
| | TSH | 2036 | 2436 | 2836 | 3036 | 3236 | 3636 | 4036 | 4436 | 4836 |
| 3'-3 1/2" | 3'-4 1/4" | | | | | | | | | |
| | TSH | 2040 | 2440 | 2840 | 3040 | 3240 | 3640 | 4040 | 4440 | 4840 |
| 3'-5 1/2" | 3'-6 1/4" | | | | | | | | | |
| | TSH | 2042 | 2442 | 2842 | 3042 | 3242 | 3642 | 4042 | 4442 | 4842 |
| 3'-11 1/2" | 4'-0 1/4" | | | | | | | | | |
| | TSH | 2048 | 2448 | 2848 | 3048 | 3248 | 3648 | 4048 | 4448 | 4848 |
| 4'-3 1/2" | 4'-4 1/4" | | | | | | | | | |
| | TSH | 2052 | 2452 | 2852 | 3052 | 3252 | 3652 | 4052 | 4452 | 4852 |
| 4'-7 1/2" | 4'-8 1/4" | | | | | | | | | |
| | TSH | 2056 | 2456 | 2856 | 3056 | 3256 | 3656 | 4056 | 4456 | 4856 |
| 4'-11 1/2" | 5'-0 1/4" | | | | | | | | | |
| | TSH | 2060 | 2460 | 2860 | 3060 | 3260 | 3660 | 4060 E | 4460 E | 4860 E |
| 5'-3 1/2" | 5'-4 1/4" | | | | | | | | | |
| | TSH | 2064 | 2464 | 2864 | 3064 | 3264 | 3664 | 4064 E | 4464 E | 4864 E |
| 5'-4 1/2" | 5'-5 1/4" | | | | | | | | | |
| | TSH | 2065 | 2465 | 2865 | 3065 | 3265 | 3665 E | 4065 E | 4465 E | 4865 E |
| 5'-11 1/2" | 6'-0 1/4" | | | | | | | | | |
| | TSH | 2072 | 2472 | 2872 | 3072 | 3272 | 3672 E | 4072 E | 4472 E | 4872 E |

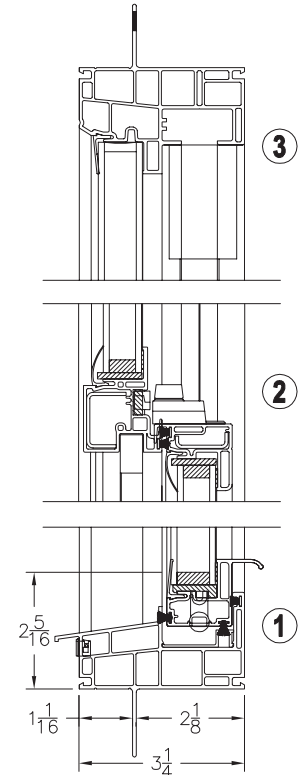

MULTIPLE ASSEMBLIES

All single-hung and double-hung units shown on pages 20 and 21 are available in 2- and 3-wide assemblies.

TWO WIDE ASSEMBLIES



THREE WIDE ASSEMBLIES

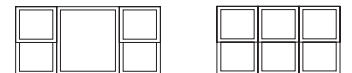

MULTIPLE ASSEMBLY CONVERSIONS













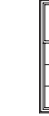

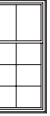
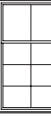



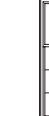

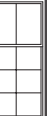







| Rough Opening | |
|--|--|
| WIDTH | HEIGHT |
| Add all frame sizes plus 3/4" and 1/8" per standard mull | Add all frame sizes plus 3/4" and 1/8" per standard mull |





Thermo-Tech's single-hung and double-hung windows are available in cottage style. Or use the larger bottom sash to keep the meeting rail from your line of sight in your lake home. These

windows have the same great Thermo-Tech features and benefits as our standard single-hung and double-hung units.

Please specify Thermo-Tech double-hung (TDH) or Thermo-Tech single-hung (TSH) when ordering. Grid configuration will change, depending on type of unit.

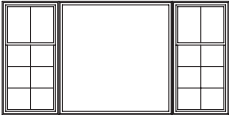
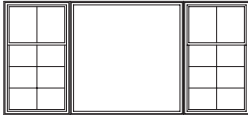
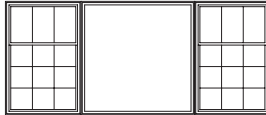
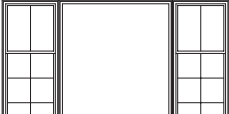
| COTTAGE STYLE WINDOWS | | | | | | | | | | | | | | | | | |
|-----------------------|------------|--|--|--|--|--|--|--|--|---|-----------|-----------|-----------|-----------|-----------|-----------|------|
| WINDOW DIMENSIONS | | 1'-7 1/2" | 1'-11 1/2" | 2'-3 1/2" | 2'-7 1/2" | 2'-11 1/2" | 3'-3 1/2" | 3'-7 1/2" | 3'-11 1/2" | | | | | | | | |
| | | WIDTH | | | | | | | | | | | | | | | |
| | | ROUGH OPENINGS | | | | | | | 1'-8 1/4" | 2'-0 1/4" | 2'-4 1/4" | 2'-8 1/4" | 3'-0 1/4" | 3'-4 1/4" | 3'-8 1/4" | 4'-0 1/4" | |
| HEIGHT | | | | | | | | | | | | | | | | | |
| | 3'-11 1/2" | 4'-0 1/4" |  |  |  |  |  |  |  |  | 2048 | 2448 | 2848 | 3248 | 3648 | 4048 | 4448 |
| 4'-3 1/2" | 4'-4 1/4" |  |  |  |  |  |  |  |  | 2052 | 2452 | 2852 | 3252 | 3652 | 4052 | 4452 | 4852 |
| 4'-7 1/2" | 4'-8 1/4" |  |  |  |  |  |  |  |  | 2056 | 2456 | 2856 | 3256 | 3656 | 4056 | 4456 | 4856 |
| 4'-11 1/2" | 5'-0 1/4" |  |  |  |  |  |  |  |  | 2060 | 2460 | 2860 | 3260 | 3660 | 4060 | 4460 | 4860 |

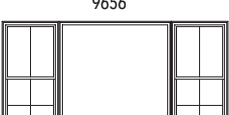
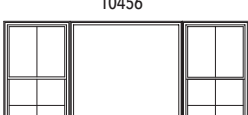
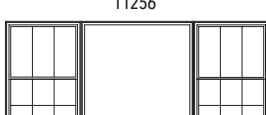



























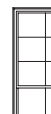



| PICTURE WINDOWS WITH COTTAGE STYLE FLANKING UNITS | | | | | | | | | | |
|---|------------|---|---|--|--|-------------|-------|------------|-----------|-----------|
| UNIT NUMBER | | 24" 48" 24" | | 28" 48" 28" | | 32" 48" 32" | | | | |
| WINDOW DIMENSIONS | | 7'-10 3/4" | | 8'-6 3/4" | | 9'-2 3/4" | | | | |
| | | WIDTH | | | | | | | | |
| | | ROUGH OPENINGS | | | | | | 7'-11 1/2" | 8'-7 1/2" | 9'-3 1/2" |
| HEIGHT | | | | | | | | | | |
| | 3'-11 1/2" | 4'-0 1/4" |  |  |  | 9648 | 10448 | 11248 | | |
| 4'-7 1/2" | 4'-8 1/4" |  |  |  | 9656 | 10456 | 11256 | | | |
| 4'-11 1/2" | 5'-0 1/4" |  |  |  | 9660 | 10460 | 11260 | | | |







Maybe a smaller bottom sash is more your style. Now Thermo-Tech offers single-hung and double-hung windows in oriel style, too. Enjoy your lake view or just try something different.

Oriel windows have all the features and benefits of the standard single-hung and double-hung windows but give you the choice of having smaller bottom sashes.

Please specify Thermo-Tech double-hung (TDH) or Thermo-Tech single-hung (TSH) when ordering. Grid configuration will change, depending on type of unit.

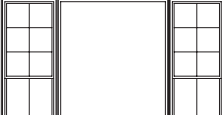
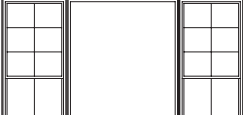
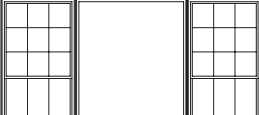
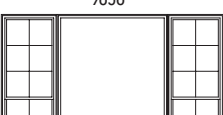
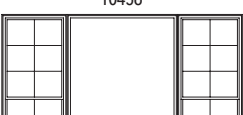
| ORIEL STYLE WINDOWS | | | | | | | | | |
|---------------------|---|---|---|---|---|---|---|---|---|
| WINDOW DIMENSIONS | | 1'-7 1/2" | 1'-11 1/2" | 2'-3 1/2" | 2'-7 1/2" | 2'-11 1/2" | 3'-3 1/2" | 3'-7 1/2" | 3'-11 1/2" |
| | | WIDTH | | | | | | | |
| | | ROUGH OPENINGS | | | | | | | |
| HEIGHT | 3'-11 1/2" |  |  |  |  |  |  |  |  |
| | 4'-0 1/4" | 2048 | 2448 | 2848 | 3248 | 3648 | 4048 | 4448 | 4848 |
| | 4'-3 1/2" |  |  |  |  |  |  |  |  |
| | 4'-4 1/4" | 2052 | 2452 | 2852 | 3252 | 3652 | 4052 | 4452 | 4852 |
| 4'-7 1/2" |  |  |  |  |  |  |  |  | |
| 4'-8 1/4" | 2056 | 2456 | 2856 | 3256 | 3656 | 4056 | 4456 | 4856 | |
| 4'-11 1/2" |  |  |  |  |  |  |  |  | |
| 5'-0 1/4" | 2060 | 2460 | 2860 | 3260 | 3660 | 4060 | 4460 | 4860 | |

| PICTURE WINDOWS WITH ORIEL STYLE FLANKING UNITS | | | | |
|---|---|---|--|--|
| UNIT NUMBER WIDTH | | 24" 48" 24" | 28" 48" 28" | 32" 48" 32" |
| WINDOW DIMENSIONS | | 7'-10 3/4" | 8'-6 3/4" | 9'-2 3/4" |
| | | WIDTH | | |
| | | ROUGH OPENINGS | | |
| HEIGHT | 3'-11 1/2" |  |  |  |
| | 4'-0 1/4" | 9648 | 10448 | 11248 |
| | 4'-7 1/2" |  |  |  |
| 4'-8 1/4" | 9656 | 10456 | 11256 | |
| 4'-11 1/2" |  |  |  | |
| 5'-0 1/4" | 9660 | 10460 | 11260 | |



Thermo-Tech offers an array of standard multiple-wide units for impressive results. Specify casements, double-hung or single-hung windows, or any multiple-wide combination. Multiple-wide configurations with casement flanking units typically use a fixed casement picture window. Double-hung and single-hung units typically have a direct-set window. These multiple-wide units include all the standard features and benefits of their respective window types.



Must specify Thermo-Tech casement (TC), Thermo-Tech double-hung (TDH) or Thermo-Tech single-hung (TSH) when ordering. Grid configuration will change, depending on type of flanking units.

| PICTURE WINDOWS WITH FLANKING UNITS | | | | | |
|-------------------------------------|------------|----------------|-------------|-------------|-----------|
| UNIT NUMBER | WIDTH | 24" 48" 24" | 28" 48" 28" | 32" 48" 32" | |
| WINDOW DIMENSIONS | | 7'-10 3/4" | 8'-6 3/4" | 9'-2 3/4" | |
| | | ROUGH OPENINGS | 7'-11 1/2" | 8'-7 1/2" | 9'-3 1/2" |
| HEIGHT | 2'-11 1/2" | 3'-0 1/4" | | | |
| | | | 9636 | 10436 | 11236 |
| | 3'-5 1/2" | 3'-6 1/4" | | | |
| | | | 9642 | 10442 | 11242 |
| | 3'-11 1/2" | 4'-0 1/4" | | | |
| | | 9648 | 10448 | 11248 | |
| 4'-7 1/2" | 4'-8 1/4" | | | | |
| | | 9656 | 10456 | 11256 | |
| 4'-11 1/2" | 5'-0 1/4" | | | | |
| | | 9660 | 10460 | 11260 | |

NOTE: Verify local or state egress opening sizes with your local building inspector.

Ask your customer service representative for egress information.

| PICTURE WINDOWS WITH FLANKING UNITS | | | | | |
|-------------------------------------|------------|----------------|-------------|-------------|-------|
| UNIT NUMBER | WIDTH | 24" 60" 24" | 28" 60" 28" | 32" 60" 32" | |
| WINDOW DIMENSIONS | | 8'-10 3/4" | 9'-6 3/4" | 10'-2 3/4" | |
| | | ROUGH OPENINGS | | | |
| | | 8'-11 1/2" | 9'-7 1/2" | 10'-3 1/2" | |
| HEIGHT | 2'-11 1/2" | 3'-0 1/4" | | | |
| | | | 10836 | 11636 | 12436 |
| | 3'-5 1/2" | 3'-6 1/4" | | | |
| | | | 10842 | 11642 | 12442 |
| | 3'-11 1/2" | 4'-0 1/4" | | | |
| | | 10848 | 11648 | 12448 | |
| 4'-7 1/2" | 4'-8 1/4" | | | | |
| | | 10856 | 11656 | 12456 | |
| 4'-11 1/2" | 5'-0 1/4" | | | | |
| | | 10860 | 11660 | 12460 | |

| PICTURE WINDOWS WITH FLANKING UNITS | | | | | |
|-------------------------------------|------------|----------------|-------------|-------------|-------|
| UNIT NUMBER | WIDTH | 24" 72" 24" | 28" 72" 28" | 32" 72" 32" | |
| WINDOW DIMENSIONS | | 9'-10 3/4" | 10'-6 3/4" | 11'-2 3/4" | |
| | | ROUGH OPENINGS | | | |
| | | 9'-11 1/2" | 10'-7 1/2" | 11'-3 1/2" | |
| HEIGHT | 2'-11 1/2" | 3'-0 1/4" | | | |
| | | | 12036 | 12836 | 13636 |
| | 3'-5 1/2" | 3'-6 1/4" | | | |
| | | | 12042 | 12842 | 13642 |
| | 3'-11 1/2" | 4'-0 1/4" | | | |
| | | 12048 | 12848 | 13648 | |
| 4'-7 1/2" | 4'-8 1/4" | | | | |
| | | 12056 | 12856 | 13656 | |
| 4'-11 1/2" | 5'-0 1/4" | | | | |
| | | 12060 | 12860 | 13660 | |

NOTE: Verify local or state egress opening sizes with your local building inspector. Ask your customer service representative for egress information.

Thermo-Tech bow windows extend outward to create an illusion of a rounded exterior wall, subtly increasing interior spaces. A bow window consists of 4, 5 or 6 different window units installed on a radius from the wall of the building. Thermo-Tech bow windows arrive fully assembled and ready to install – complete with jamb extensions, head and seat board, and back-up cable support system.



Must specify Thermo-Tech casement (TC), Thermo-Tech direct set (TDS), Thermo-Tech double-hung (TDH) or Thermo-Tech single-hung (TSH) when ordering. Grid configuration will change, depending on type of units.

4-LITE BOW WINDOWS

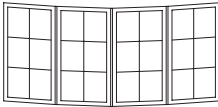
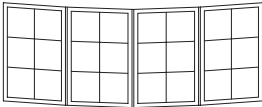
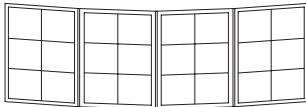
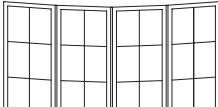
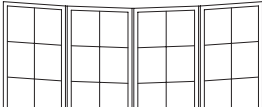
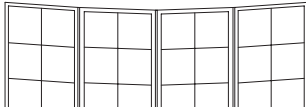
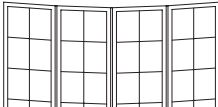
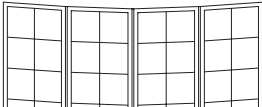
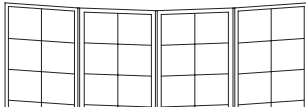
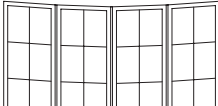
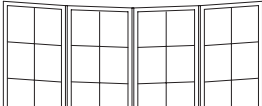
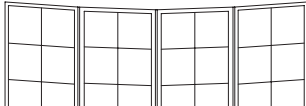
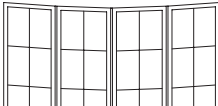
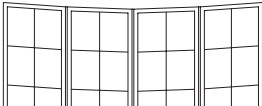
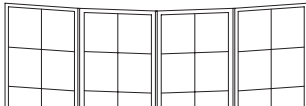

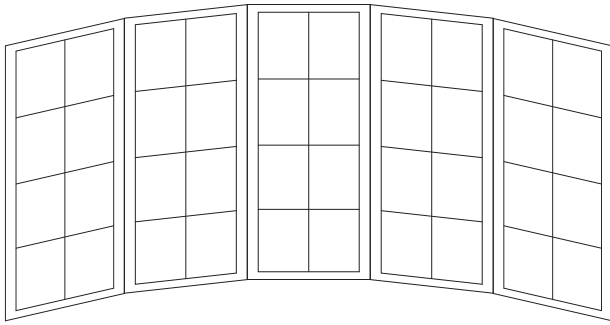
| UNIT NUMBER | WIDTH | 20" | 24" | 28" |
|------------------|----------------|---|---|---|
| PROJECTION | | 8 3/8" | 9 3/4" | 11 1/8" |
| FRAME DIMENSIONS | | 6'-6" | 7'-9 11/16" | 9'-1 3/8" |
| | WIDTH | | | |
| | ROUGH OPENINGS | 6'-6 1/2" | 7'-10 3/16" | 9'-1 7/8" |
| | HEIGHT | | | |
| 2'-11 1/2" | 3'-0 1/4" |  4-2036 |  4-2436 |  4-2836 |
| 3'-5 1/2" | 3'-6 1/4" |  4-2042 |  4-2442 |  4-2842 |
| 3'-11 1/2" | 4'-0 1/4" |  4-2048 |  4-2448 |  4-2848 |
| 4'-7 1/2" | 4'-8 1/4" |  4-2056 |  4-2456 |  4-2856 |
| 4'-11 1/2" | 5'-0 1/4" |  4-2060 |  4-2460 |  4-2860 |

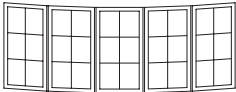
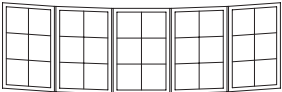
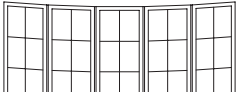
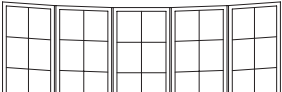
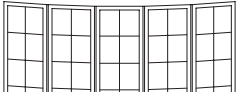
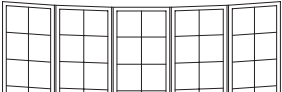
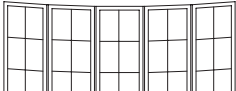
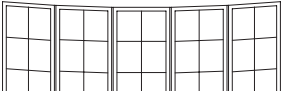
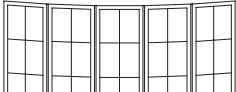
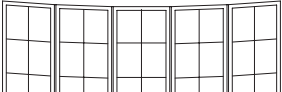

As with all our products, Thermo-Fit custom size windows are available.

Ask your customer service representative for more information.

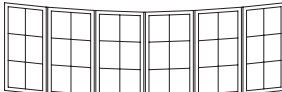
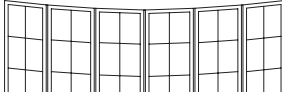
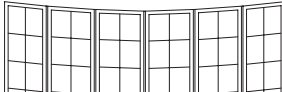
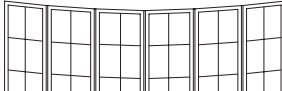
| 5-LITE BOW WINDOWS | | |
|--------------------|----------------|---|
| UNIT NUMBER | WIDTH | 24" |
| PROJECTION | 11 3/4" | 13 13/16" |
| FRAME DIMENSIONS | 8'-1/16" | 9'-7 1/2" |
| | ROUGH OPENINGS | 9'-8" |
| HEIGHT | WIDTH | |
| 2'-11 1/2" | 3'-0 1/4" |  5-2036 |
| | |  5-2436 |
| 3'-5 1/2" | 3'-6 1/4" |  5-2042 |
| | |  5-2442 |
| 3'-11 1/2" | 4'-0 1/4" |  5-2048 |
| | |  5-2448 |
| 4'-7 1/2" | 4'-8 1/4" |  5-2056 |
| | |  5-2456 |
| 4'-11 1/2" | 5'-0 1/4" |  5-2060 |
| | |  5-2460 |

| 6-LITE BOW WINDOWS | | |
|--------------------|----------------|---|
| UNIT NUMBER | WIDTH | 20" |
| PROJECTION | 16 7/8" | |
| FRAME DIMENSIONS | 9'-5 7/16" | |
| | ROUGH OPENINGS | 9'-5 15/16" |
| HEIGHT | WIDTH | |
| 2'-11 1/2" | 3'-0 1/4" |  6-2036 |
| 3'-5 1/2" | 3'-6 1/4" |  6-2042 |
| 3'-11 1/2" | 4'-0 1/4" |  6-2048 |
| 4'-7 1/2" | 4'-8 1/4" |  6-2056 |
| 4'-11 1/2" | 5'-0 1/4" |  6-2060 |



Thermo-Tech bay windows are ideal for classic architecture, increasing the sense of openness in any room. Bay windows are composed of three to five individual units. The center unit is parallel to the exterior wall with side flanking units at 30 or 45 degree angles. Thermo-Tech bay windows arrive fully assembled and ready to install – complete with jamb extensions, head and seat board, and back-up cable support system.



45° BAY WINDOWS WITH 20" FLANKING UNITS

| UNIT NUMBER | | 36 | 48 | 60 | 72 | 84 |
|------------------------|------------|------------|------------|------------|------------|------------|
| WIDTH | | 20 | 20 | 20 | 20 | 20 |
| CENTER UNIT DIMENSIONS | | 2'-11 1/2" | 3'-11 1/2" | 4'-11 1/2" | 5'-11 1/2" | 6'-11 1/2" |
| ROUGH OPENINGS | | 5'-5 1/4" | 6'-5 1/4" | 7'-5 1/4" | 8'-5 1/4" | 9'-5 1/4" |
| HEIGHT | 2'-11 1/2" | 20-3636 | 20-4836 | 20-6036 | 20-7236 | 20-8436 |
| | 3'-5 1/2" | 20-3642 | 20-4842 | 20-6042 | 20-7242 | 20-8442 |
| | 3'-11 1/2" | 20-3648 | 20-4848 | 20-6048 | 20-7248 | 20-8448 |
| | 4'-7 1/2" | 20-3656 | 20-4856 | 20-6056 | 20-7256 | 20-8456 |
| | 4'-11 1/2" | 20-3660 | 20-4860 | 20-6060 | 20-7260 | 20-8460 |

Projection from sheathing 16 1/2"

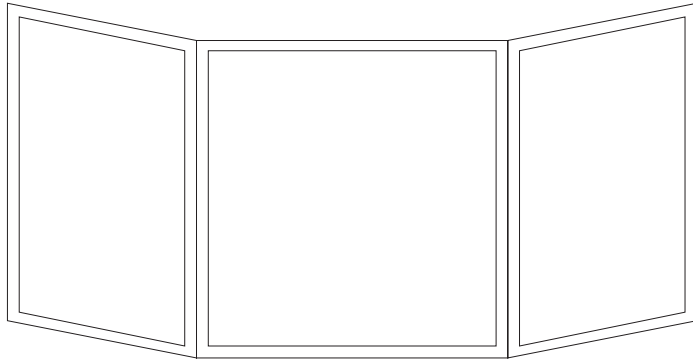

For bay windows, typically three windows are joined together. The center of the window is fixed, with your choice of single-hung, double-hung or casement windows at the sides.

Must specify Thermo-Tech casement (TC), Thermo-Tech double-hung (TDH) or Thermo-Tech single-hung (TSH) when ordering. Grid configuration will change, depending on type of flanking units.

| 30° BAY WINDOWS WITH 20" FLANKING UNITS | | | | | | |
|---|----------------|-------------|-------------|-------------|-------------|-------------|
| UNIT NUMBER | WIDTH | 36 | 48 | 60 | 72 | 84 |
| | | | | | | |
| CENTER UNIT DIMENSIONS | | 2'-11 1/2" | 3'-11 1/2" | 4'-11 1/2" | 5'-11 1/2" | 6'-11 1/2" |
| | ROUGH OPENINGS | 5'-11 3/8" | 6'-11 3/8" | 7'-11 3/8" | 8'-11 3/8" | 9'-11 3/8" |
| HEIGHT | 2'-11 1/2" | 20-3636 | 20-4836 | 20-6036 | 20-7236 | 20-8436 |
| | 3'-5 1/2" | 20-3642 | 20-4842 | 20-6042 | 20-7242 | 20-8442 |
| | 3'-11 1/2" | 20-3648 | 20-4848 | 20-6048 | 20-7248 | 20-8448 |
| | 4'-7 1/2" | 20-3656 | 20-4856 | 20-6056 | 20-7256 | 20-8456 |
| | 4'-11 1/2" | 20-3660 | 20-4860 | 20-6060 | 20-7260 | 20-8460 |

Projection from sheathing 11 13/16"



45° BAY WINDOWS WITH 24" FLANKING UNITS

| UNIT NUMBER | | 24 | 36 | 24 | 24 | 48 | 24 | 24 | 60 | 24 | 72 | 24 | 24 | 84 | 24 | |
|------------------------|------------|----------------|-----------|--------------|---------|--------------|---------|--------------|----|--------------|----|--------------|----|----|----|--|
| CENTER UNIT DIMENSIONS | | 2'-11 1/2" | | 3'-11 1/2" | | 4'-11 1/2" | | 5'-11 1/2" | | 6'-11 1/2" | | | | | | |
| | | WIDTH | | | | | | | | | | | | | | |
| | | ROUGH OPENINGS | | 5'-10 15/16" | | 6'-10 15/16" | | 7'-10 15/16" | | 8'-10 15/16" | | 9'-10 15/16" | | | | |
| HEIGHT | 2'-11 1/2" | 3'-0 1/4" | | | | | | | | | | | | | | |
| | 24-3636 | | 24-4836 | 24-6036 | 24-7236 | 24-8436 | | | | | | | | | | |
| | 3'-5 1/2" | | 3'-6 1/4" | | | | | | | | | | | | | |
| | 24-3642 | | | 24-4842 | 24-6042 | 24-7242 | 24-8442 | | | | | | | | | |
| | 3'-11 1/2" | | | 4'-0 1/4" | | | | | | | | | | | | |
| 24-3648 | 24-4848 | 24-6048 | | | 24-7248 | 24-8448 | | | | | | | | | | |
| 4'-7 1/2" | 4'-8 1/4" | | | | | | | | | | | | | | | |
| 24-3656 | | 24-4856 | 24-6056 | 24-7256 | 24-8456 | | | | | | | | | | | |
| 4'-11 1/2" | 5'-0 1/4" | | | | | | | | | | | | | | | |
| 24-3660 | | 24-4860 | 24-6060 | 24-7260 | 24-8460 | | | | | | | | | | | |

Projection from sheathing 19 5/16"

30° BAY WINDOWS WITH 24" FLANKING UNITS

| CENTER UNIT DIMENSIONS | | 2'-11 1/2" | | 3'-11 1/2" | | 4'-11 1/2" | | 5'-11 1/2" | | | |
|------------------------|------------|----------------|-----------|------------|---------|------------|--|------------|--|------------|--|
| | | WIDTH | | | | | | | | | |
| | | ROUGH OPENINGS | | 6'-6 5/16" | | 7'-6 5/16" | | 8'-6 5/16" | | 9'-6 5/16" | |
| HEIGHT | 2'-11 1/2" | 3'-0 1/4" | | | | | | | | | |
| | 24-3636 | | 24-4836 | 24-6036 | 24-7236 | | | | | | |
| | 3'-5 1/2" | | 3'-6 1/4" | | | | | | | | |
| | 24-3642 | | | 24-4842 | 24-6042 | 24-7242 | | | | | |
| | 3'-11 1/2" | | | 4'-0 1/4" | | | | | | | |
| 24-3648 | 24-4848 | 24-6048 | | | 24-7248 | | | | | | |
| 4'-7 1/2" | 4'-8 1/4" | | | | | | | | | | |
| 24-3656 | | 24-4856 | 24-6056 | 24-7256 | | | | | | | |
| 4'-11 1/2" | 5'-0 1/4" | | | | | | | | | | |
| 24-3660 | | 24-4860 | 24-6060 | 24-7260 | | | | | | | |

Must specify Thermo-Tech casement (TC), Thermo-Tech double-hung (TDH) or Thermo-Tech single-hung (TSH) when ordering.

Grid configuration will change, depending on type of flanking units.

Projection from sheathing 13 13/16"



45° BAY WINDOWS WITH 28" FLANKING UNITS

| UNIT NUMBER WIDTH | | 28 36 28 | 28 48 28 | 28 60 28 | 28 72 28 |
|------------------------|------------|------------|------------|------------|------------|
| CENTER UNIT DIMENSIONS | | 2'-11 1/2" | 3'-11 1/2" | 4'-11 1/2" | 5'-11 1/2" |
| ROUGH OPENINGS | | 6'-4 9/16" | 7'-4 9/16" | 8'-4 9/16" | 9'-4 9/16" |
| HEIGHT | 2'-11 1/2" | 3'-0 1/4" | | | |
| | 3'-5 1/2" | 3'-6 1/4" | | | |
| | 3'-11 1/2" | 4'-0 1/4" | | | |
| | 4'-7 1/2" | 4'-8 1/4" | | | |
| | 4'-11 1/2" | 5'-0 1/4" | | | |
| | | 28-3636 | 28-4836 | 28-6036 | 28-7236 |
| | | 28-3642 | 28-4842 | 28-6042 | 28-7242 |
| | | 28-3648 | 28-4848 | 28-6048 | 28-7248 |
| | | 28-3656 | 28-4856 | 28-6056 | 28-7256 |
| | | 28-3660 | 28-4860 | 28-6060 | 28-7260 |

Projection from sheathing 22 1/8"

30° BAY WINDOWS WITH 28" FLANKING UNITS

| CENTER UNIT DIMENSIONS | | 2'-11 1/2" | 3'-11 1/2" | 4'-11 1/2" |
|------------------------|------------|------------|------------|------------|
| ROUGH OPENINGS | | 7'-1 1/4" | 8'-1 1/4" | 9'-1 1/4" |
| HEIGHT | 2'-11 1/2" | 3'-0 1/4" | | |
| | 3'-5 1/2" | 3'-6 1/4" | | |
| | 3'-11 1/2" | 4'-0 1/4" | | |
| | 4'-7 1/2" | 4'-8 1/4" | | |
| | 4'-11 1/2" | 5'-0 1/4" | | |
| | | 28-3636 | 28-4836 | 28-6036 |
| | | 28-3642 | 28-4842 | 28-6042 |
| | | 28-3648 | 28-4848 | 28-6048 |
| | | 28-3656 | 28-4856 | 28-6056 |
| | | 28-3660 | 28-4860 | 28-6060 |



Must specify Thermo-Tech casement (TC), Thermo-Tech double-hung (TDH) or Thermo-Tech single-hung (TSH) when ordering.

Grid configuration will change, depending on type of flanking units.

Projection from sheathing 15 13/16"

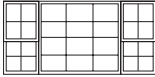
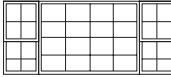
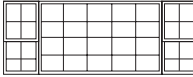
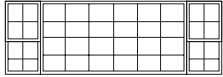
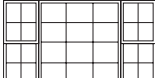
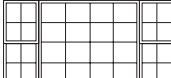
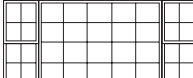
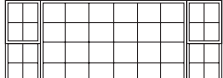

45° BAY WINDOWS WITH 32" FLANKING UNITS

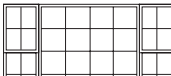
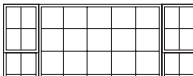
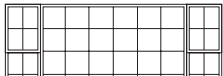
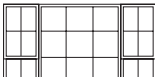
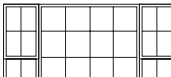
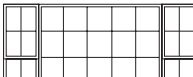
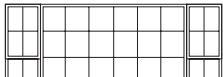
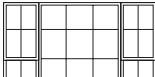
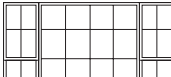
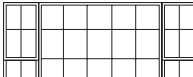
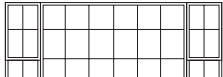
| UNIT NUMBER WIDTH | | 36 | 48 | 60 | 72 |
|------------------------|-----------|--|--|---|--|
| CENTER UNIT DIMENSIONS | | 2'-11 1/2" | 3'-11 1/2" | 4'-11 1/2" | 5'-11 1/2" |
| ROUGH OPENINGS | | 6'-10 1/4" | 7'-10 1/4" | 8'-10 1/4" | 9'-10 1/4" |
| HEIGHT | WIDTH | | | | |
| 2'-11 1/2" | 3'-0 1/4" |  32-3636 |  32-4836 |  32-6036 |  32-7236 |
| 3'-5 1/2" | 3'-6 1/4" |  32-3642 |  32-4842 |  32-6042 |  32-7242 |
| 3'-11 1/2" | 4'-0 1/4" |  32-3648 |  32-4848 |  32-6048 |  32-7248 |
| 4'-7 1/2" | 4'-8 1/4" |  32-3656 |  32-4856 |  32-6056 |  32-7256 |
| 4'-11 1/2" | 5'-0 1/4" |  32-3660 |  32-4860 |  32-6060 |  32-7260 |

Projection from sheathing 24 15/16"



Must specify Thermo-Tech casement (TC), Thermo-Tech double-hung (TDH) or Thermo-Tech single-hung (TSH) when ordering.

Grid configuration will change, depending on type of flanking units.

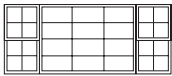

30° BAY WINDOWS WITH 32" FLANKING UNITS

Must specify Thermo-Tech casement (TC), Thermo-Tech double-hung (TDH) or Thermo-Tech single-hung (TSH) when ordering.
Grid configuration will change, depending on type of flanking units.

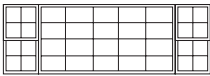
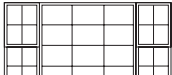
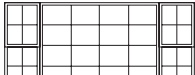
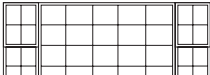
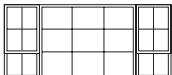
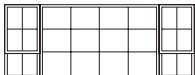
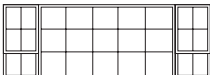
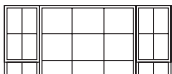
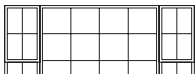
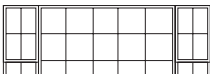
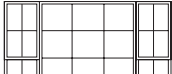
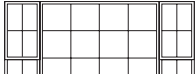
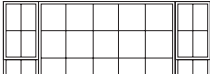
| CENTER UNIT DIMENSIONS | | 2'-11 1/2" | 3'-11 1/2" | 4'-11 1/2" |
|------------------------|----------------|--|--|---|
| | WIDTH | | | |
| | ROUGH OPENINGS | 7'-8 1/8" | 8'-8 1/8" | 9'-8 1/8" |
| HEIGHT | 2'-11 1/2" |  32-3636 |  32-4836 |  32-6036 |
| | 3'-5 1/2" |  32-3642 |  32-4842 |  32-6042 |
| | 3'-11 1/2" |  32-3648 |  32-4848 |  32-6048 |
| | 4'-7 1/2" |  32-3656 |  32-4856 |  32-6056 |
| | 4'-11 1/2" |  32-3660 |  32-4860 |  32-6060 |

Projection from sheathing 17 13/16"



Thermo-Tech stationary transom windows fit exactly over our standard-size operable and stationary windows. Direct-set transoms are designed to stack vertically on single-hung, double-hung and other fixed units. Fixed casement transoms match the framing of our casement and awning windows to ensure a

consistent and seamless appearance. For dramatic wall effects, use the transom window to extend the vertical reach of windows. As with all of our windows, Thermo-Tech offers options for virtually limitless possibilities. Let your imagination be your guide. For more standard size options, see page 16-17.

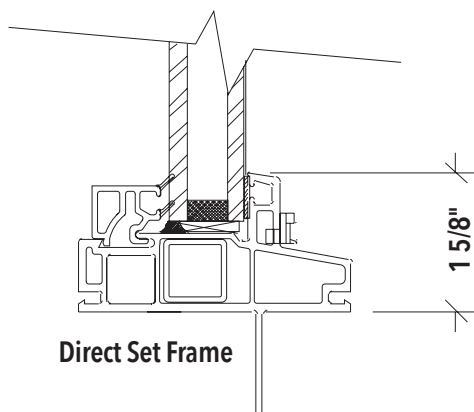
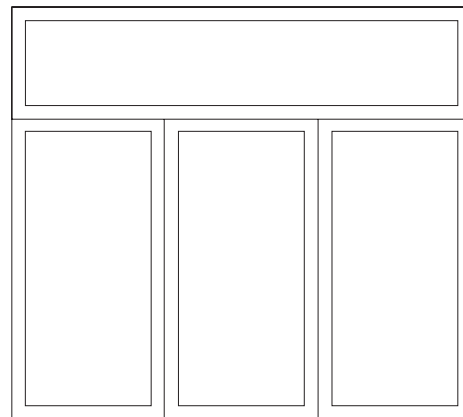
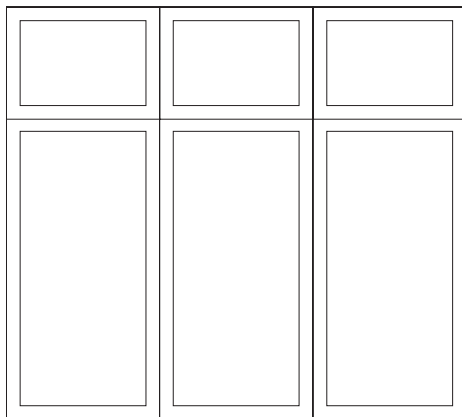
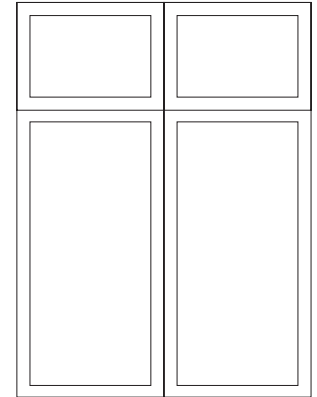
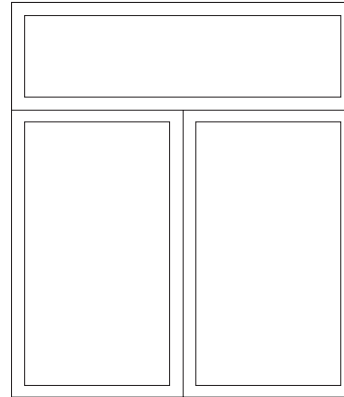
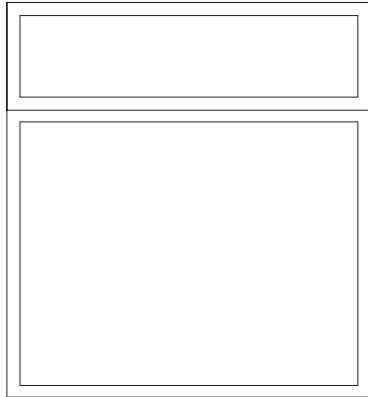
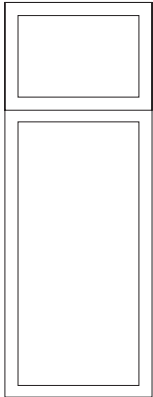

Direct Set Frame

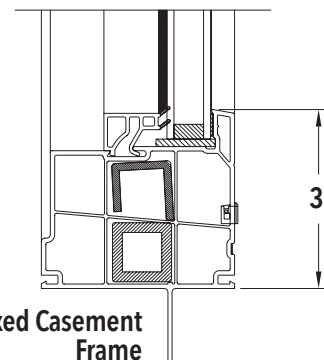

Fixed Casement Frame

STANDARD SIZE 12" DIRECT-SET TRANSOMS

Transoms for Double-Hungs, Single-Hungs and Sliders

| ORDER NO. | UNIT SIZE | ROUGH OPENING |
|--------------------------------|---------------|-------------------|
| FIT OVER SINGLE UNITS | | |
| TDS 2012* | 19 1/2" X 12" | 20 1/4" X 12 3/4" |
| TDS 2412* | 23 1/2" X 12" | 24 1/4" X 12 3/4" |
| TDS 2812* | 27 1/2" X 12" | 28 1/4" X 12 3/4" |
| TDS 3012* | 29 1/2" X 12" | 30 1/4" X 12 3/4" |
| TDS 3212* | 31 1/2" X 12" | 32 1/4" X 12 3/4" |
| FIT OVER SLIDERS & DIRECT-SETS | | |
| TDS 3612* | 35 1/2" X 12" | 36 1/4" X 12 3/4" |
| TDS 4012* | 39 1/2" X 12" | 40 1/4" X 12 3/4" |
| TDS 4412* | 43 1/2" X 12" | 44 1/4" X 12 3/4" |
| TDS 4812* | 47 1/2" X 12" | 48 1/4" X 12 3/4" |
| TDS 5012* | 49 1/2" X 12" | 50 1/4" X 12 3/4" |
| TDS 5212* | 51 1/2" X 12" | 52 1/4" X 12 3/4" |

| ORDER NO. | UNIT SIZE | ROUGH OPENING |
|------------------------------|---------------|-------------------|
| FIT OVER 2-WIDE MULLED UNITS | | |
| TDS 2-2012* | 39 1/8" X 12" | 39 7/8" X 12 3/4" |
| TDS 2-2412* | 47 1/8" X 12" | 47 7/8" X 12 3/4" |
| TDS 2-2812* | 55 1/8" X 12" | 55 7/8" X 12 3/4" |
| TDS 2-3012* | 59 1/8" X 12" | 59 7/8" X 12 3/4" |
| TDS 2-3212* | 63 1/8" X 12" | 63 7/8" X 12 3/4" |
| TDS 2-3612* | 71 1/8" X 12" | 71 7/8" X 12 3/4" |
| TDS 2-4012* | 79 1/8" X 12" | 79 7/8" X 12 3/4" |
| TDS 2-4412* | 87 1/8" X 12" | 87 7/8" X 12 3/4" |
| TDS 2-4812* | 95 1/8" X 12" | 95 7/8" X 12 3/4" |

| ORDER NO. | UNIT SIZE | ROUGH OPENING |
|--|---------------|-------------------|
| SINGLE UNIT TO FIT OVER 2-WIDE MULLED UNIT | | |
| TDS 3912* | 39 1/8" X 12" | 39 7/8" X 12 3/4" |
| TDS 4712* | 47 1/8" X 12" | 47 7/8" X 12 3/4" |
| TDS 5512* | 55 1/8" X 12" | 55 7/8" X 12 3/4" |
| TDS 6312* | 63 1/8" X 12" | 63 7/8" X 12 3/4" |
| TDS 7112* | 71 1/8" X 12" | 71 7/8" X 12 3/4" |
| TDS 7912* | 79 1/8" X 12" | 79 7/8" X 12 3/4" |
| SINGLE UNIT TO FIT OVER 3-WIDE MULLED UNIT | | |
| TDS 5912* | 58 3/4" X 12" | 59 1/2" X 12 3/4" |
| TDS 71512* | 70 3/4" X 12" | 71 1/2" X 12 3/4" |
| TDS 8312* | 82 3/4" X 12" | 83 1/2" X 12 3/4" |

| ORDER NO. | UNIT SIZE | ROUGH OPENING |
|------------------------------|----------------|--------------------|
| FIT OVER 3-WIDE MULLED UNITS | | |
| TDS 3-2012* | 58 3/4" X 12" | 59 1/2" X 12 3/4" |
| TDS 3-2412* | 70 3/4" X 12" | 71 1/2" X 12 3/4" |
| TDS 3-2812* | 82 3/4" X 12" | 83 1/2" X 12 3/4" |
| TDS 3-3012* | 88 3/4" X 12" | 89 1/2" X 12 3/4" |
| TDS 3-3212* | 94 3/4" X 12" | 95 1/2" X 12 3/4" |
| TDS 3-3612* | 106 3/4" X 12" | 107 1/2" X 12 3/4" |
| TDS 3-4012* | 118 3/4" X 12" | 119 1/2" X 12 3/4" |
| TDS 3-4412* | 130 3/4" X 12" | 131 1/2" X 12 3/4" |
| TDS 3-4812* | 142 3/4" X 12" | 143 1/2" X 12 3/4" |

| ORDER NO. | UNIT SIZE | ROUGH OPENING |
|--|---------------|-------------------|
| SINGLE UNIT TO FIT OVER 3-LITE SLIDERS | | |
| TDS 72512* | 71 1/2" X 12" | 72 1/4" X 12 3/4" |
| TDS 8412* | 83 1/2" X 12" | 84 1/4" X 12 3/4" |
| TDS 9612* | 95 1/2" X 12" | 96 1/4" X 12 3/4" |

STANDARD SIZE 18" DIRECT-SET TRANSOMS

Transoms for Double-Hungs, Single-Hungs and Sliders

| ORDER NO. | UNIT SIZE | ROUGH OPENING |
|--------------------------------|-------------------|-------------------|
| FIT OVER SINGLE UNITS | | |
| TDS 2018* | 19 1/2" X 17 1/2" | 20 1/4" X 18 1/4" |
| TDS 2418* | 23 1/2" X 17 1/2" | 24 1/4" X 18 1/4" |
| TDS 2818* | 27 1/2" X 17 1/2" | 28 1/4" X 18 1/4" |
| TDS 3018* | 29 1/2" X 17 1/2" | 30 1/4" X 18 1/4" |
| TDS 3218* | 31 1/2" X 17 1/2" | 32 1/4" X 18 1/4" |
| TDS 3618* | 35 1/2" X 17 1/2" | 36 1/4" X 18 1/4" |
| FIT OVER SLIDERS & DIRECT-SETS | | |
| TDS 4018* | 39 1/2" X 17 1/2" | 40 1/4" X 18 1/4" |
| TDS 4418* | 43 1/2" X 17 1/2" | 44 1/4" X 18 1/4" |
| TDS 4818* | 47 1/2" X 17 1/2" | 48 1/4" X 18 1/4" |
| TDS 5018* | 49 1/2" X 17 1/2" | 50 1/4" X 18 1/4" |
| TDS 5218* | 51 1/2" X 17 1/2" | 52 1/4" X 18 1/4" |

| ORDER NO. | UNIT SIZE | ROUGH OPENING |
|------------------------------|-------------------|-------------------|
| FIT OVER 2-WIDE MULLED UNITS | | |
| TDS 2-2018* | 39 1/8" X 17 1/2" | 39 7/8" X 18 1/4" |
| TDS 2-2418* | 47 1/8" X 17 1/2" | 47 7/8" X 18 1/4" |
| TDS 2-2818* | 55 1/8" X 17 1/2" | 55 7/8" X 18 1/4" |
| TDS 2-3018* | 59 1/8" X 17 1/2" | 59 7/8" X 18 1/4" |
| TDS 2-3218* | 63 1/8" X 17 1/2" | 63 7/8" X 18 1/4" |
| TDS 2-3618* | 71 1/8" X 17 1/2" | 71 7/8" X 18 1/4" |
| TDS 2-4018* | 79 1/8" X 17 1/2" | 79 7/8" X 18 1/4" |
| TDS 2-4418* | 87 1/8" X 17 1/2" | 87 7/8" X 18 1/4" |
| TDS 2-4818* | 95 1/8" X 17 1/2" | 95 7/8" X 18 1/4" |

| ORDER NO. | UNIT SIZE | ROUGH OPENING |
|--|-------------------|-------------------|
| SINGLE UNIT TO FIT OVER 2-WIDE MULLED UNIT | | |
| TDS 3918* | 39 1/8" X 17 1/2" | 39 7/8" X 18 1/4" |
| TDS 4718* | 47 1/8" X 17 1/2" | 47 7/8" X 18 1/4" |
| TDS 5518* | 55 1/8" X 17 1/2" | 55 7/8" X 18 1/4" |
| TDS 6318* | 63 1/8" X 17 1/2" | 63 7/8" X 18 1/4" |
| TDS 7118* | 71 1/8" X 17 1/2" | 71 7/8" X 18 1/4" |
| TDS 7918* | 79 1/8" X 17 1/2" | 79 7/8" X 18 1/4" |

| ORDER NO. | UNIT SIZE | ROUGH OPENING |
|------------------------------|--------------------|--------------------|
| FIT OVER 3-WIDE MULLED UNITS | | |
| TDS 3-2018* | 58 3/4" X 17 1/2" | 59 1/2" X 18 1/4" |
| TDS 3-2418* | 70 3/4" X 17 1/2" | 71 1/2" X 18 1/4" |
| TDS 3-2818* | 82 3/4" X 17 1/2" | 83 1/2" X 18 1/4" |
| TDS 3-3018* | 88 3/4" X 17 1/2" | 89 1/2" X 18 1/4" |
| TDS 3-3218* | 94 3/4" X 17 1/2" | 95 1/2" X 18 1/4" |
| TDS 3-3618* | 106 3/4" X 17 1/2" | 107 1/2" X 18 1/4" |
| TDS 3-4018* | 118 3/4" X 17 1/2" | 119 1/2" X 18 1/4" |
| TDS 3-4418* | 130 3/4" X 17 1/2" | 131 1/2" X 18 1/4" |
| TDS 3-4818* | 142 3/4" X 17 1/2" | 143 1/2" X 18 1/4" |

| ORDER NO. | UNIT SIZE | ROUGH OPENING |
|--|-------------------|-------------------|
| SINGLE UNIT TO FIT OVER 3-WIDE MULLED UNIT | | |
| TDS 5918* | 58 3/4" X 17 1/2" | 59 1/2" X 18 1/4" |
| TDS 71518* | 70 3/4" X 17 1/2" | 71 1/2" X 18 1/4" |
| TDS 8318* | 82 3/4" X 17 1/2" | 83 1/2" X 18 1/4" |

| ORDER NO. | UNIT SIZE | ROUGH OPENING |
|--|-------------------|-------------------|
| SINGLE UNIT TO FIT OVER 3-LITE SLIDERS | | |
| TDS 72518* | 71 1/2" X 17 1/2" | 72 1/4" X 18 1/4" |
| TDS 8418* | 83 1/2" X 17 1/2" | 84 1/4" X 18 1/4" |
| TDS 9618* | 95 1/2" X 17 1/2" | 96 1/4" X 18 1/4" |

STANDARD SIZE FIXED CASEMENT TRANSOMS

Transoms for Casement and Awning Windows

| ORDER NO. | UNIT SIZE | ROUGH OPENING |
|-----------------------------------|-------------------|-------------------|
| FIT OVER SINGLE UNITS | | |
| TFC 2018* | 19 1/2" X 17 1/2" | 20 1/4" X 18 1/4" |
| TFC 2418* | 23 1/2" X 17 1/2" | 24 1/4" X 18 1/4" |
| TFC 2818* | 27 1/2" X 17 1/2" | 28 1/4" X 18 1/4" |
| TFC 3218* | 31 1/2" X 17 1/2" | 32 1/4" X 18 1/4" |
| FIT OVER CASEMENT PICTURE WINDOWS | | |
| TFC 3618* | 35 1/2" X 17 1/2" | 36 1/4" X 18 1/4" |
| TFC 4818* | 47 1/2" X 17 1/2" | 48 1/4" X 18 1/4" |
| TFC 6018* | 59 1/2" X 17 1/2" | 60 1/4" X 18 1/4" |
| TFC 7218* | 71 1/2" X 17 1/2" | 72 1/4" X 18 1/4" |
| FIT OVER 2-WIDE MULLED UNITS | | |
| TFC 2-2018* | 39 1/8" X 17 1/2" | 39 3/4" X 18 1/4" |
| TFC 2-2418* | 47 1/8" X 17 1/2" | 47 3/4" X 18 1/4" |
| TFC 2-2818* | 55 1/8" X 17 1/2" | 55 3/4" X 18 1/4" |
| TFC 2-3218* | 63 1/8" X 17 1/2" | 63 3/4" X 18 1/4" |
| TFC 2-3618* | 71 1/8" X 17 1/2" | 71 7/8" X 18 1/4" |

| ORDER NO. | UNIT SIZE | ROUGH OPENING |
|------------------------------|--------------------|--------------------|
| FIT OVER 3-WIDE MULLED UNITS | | |
| TFC 3-2018* | 58 3/4" X 17 1/2" | 59 1/2" X 18 1/4" |
| TFC 3-2418* | 70 3/4" X 17 1/2" | 71 1/2" X 18 1/4" |
| TFC 3-2818* | 82 3/4" X 17 1/2" | 83 1/2" X 18 1/4" |
| TFC 3-3218* | 94 3/4" X 17 1/2" | 95 1/2" X 18 1/4" |
| TFC 3-3618* | 106 3/4" X 17 1/2" | 107 1/2" X 18 1/4" |

Also available as **Thermo-Tech® ENERGY GUARD & ENERGY GUARD PLUS Triple glass options.**

See page 7 for performance data.
Available in sizes noted with an "*".

| ORDER NO. | UNIT SIZE | ROUGH OPENING |
|------------------------------|--------------------|--------------------|
| FIT OVER 4-WIDE MULLED UNITS | | |
| TFC 4-2018* | 78 3/8" X 17 1/2" | 79 1/8" X 18 1/4" |
| TFC 4-2418* | 94 3/8" X 17 1/2" | 95 1/8" X 18 1/4" |
| TFC 4-2818* | 110 3/8" X 17 1/2" | 111 1/8" X 18 1/4" |
| TFC 4-3218* | 126 3/8" X 17 1/2" | 127 1/8" X 18 1/4" |
| TFC 4-3618* | 142 3/8" X 17 1/2" | 143 1/8" X 18 1/4" |

| ORDER NO. | UNIT SIZE | ROUGH OPENING |
|--|-------------------|-------------------|
| SINGLE UNIT TO FIT OVER 2-WIDE MULLED UNIT | | |
| TFC 3918* | 39 1/8" X 17 1/2" | 39 7/8" X 18 1/4" |
| TFC 4718* | 47 1/8" X 17 1/2" | 47 7/8" X 18 1/4" |
| TFC 5518* | 55 1/8" X 17 1/2" | 55 7/8" X 18 1/4" |
| TFC 6318* | 63 1/8" X 17 1/2" | 63 7/8" X 18 1/4" |

| ORDER NO. | UNIT SIZE | ROUGH OPENING |
|--|-------------------|-------------------|
| SINGLE UNIT TO FIT OVER 3-WIDE MULLED UNIT | | |
| TFC 5918* | 58 3/4" X 17 1/2" | 59 1/2" X 18 1/4" |
| TFC 7118* | 70 3/4" X 17 1/2" | 71 1/2" X 18 1/4" |
| TFC 8318* | 82 3/4" X 17 1/2" | 83 1/2" X 18 1/4" |

To figure rough openings for stacked units, add the unit dimension height of each window, plus 1/8" for each mull, and 3/4". Any multiple-wide stacked unit over 63" in width needs a structural mull. This requires you to add 1-1/8" for each structural mull, and 3/4".



Round-top windows from Thermo-Tech enhance a home's character. Simplify the design process with our standard sizes in popular decorative shapes, including elliptical, quarter rounds, half rounds, extended half rounds and extended elliptical windows. Combining standard styles maximizes your plan at a minimum cost, or opt

for sizes to perfectly match your design specifications. These windows work equally well as single units or joined with any of our window systems. Create combinations of shapes and styles for stunning curb appeal.

FEATURES AND BENEFITS

- Fixed glass has independent weeping.
- Upgrade to LoE³™ 366/Argon or Energy Guard triple insulated glass.
- See other options on pages 4-5.

STANDARD SIZE 1/2 ROUND UNITS

| ORDER NO. | UNIT SIZE | ROUGH OPENING | ORDER NO. | UNIT SIZE | ROUGH OPENING | ORDER NO. | UNIT SIZE | ROUGH OPENING |
|--|-------------------|-------------------|--|--------------------|--------------------|---------------------------------------|-------------------|-------------------|
| FIT OVER SINGLE UNITS | | | FIT OVER STANDARD 3-LITE SLIDERS (CENTERED) | | | STANDARD SIZE 1/4 CIRCLE UNITS | | |
| HR-24* | 23 1/2" x 11 3/4" | 24 1/4" x 12 1/2" | HR-44-35* | 43" x 21 1/2" | 43 3/4" x 22 1/4" | QR-24* | 23 1/2" x 23 1/2" | 24 1/4" x 24 1/4" |
| HR-28* | 27 1/2" x 13 3/4" | 28 1/4" x 14 1/2" | HR-48-35* | 49" x 24 1/2" | 49 3/4" x 25 1/4" | QR-28* | 27 1/2" x 27 1/2" | 28 1/4" x 28 1/4" |
| HR-32* | 31 1/2" x 15 3/4" | 32 1/4" x 16 1/2" | FIT OVER 2-WIDE MULLED UNITS | | | QR-32* | 31 1/2" x 31 1/2" | 32 1/4" x 32 1/4" |
| FIT OVER SLIDERS, DIRECT-SETS & FIXED CASEMENTS | | | HR 2-24* | 47 7/8" x 23 9/16" | 47 7/8" x 24 5/16" | QR-36* | 35 1/2" x 35 1/2" | 36 1/4" x 36 1/4" |
| HR-36* | 35 1/2" x 17 3/4" | 36 1/4" x 18 1/2" | HR 2-28* | 55 1/8" x 27 9/16" | 55 7/8" x 28 5/16" | | | |
| HR-38* | 37" x 18 1/2" | 37 3/4" x 19 1/4" | HR 2-32* | 63 1/8" x 31 9/16" | 63 7/8" x 32 5/16" | | | |
| HR-40* | 39 1/2" x 19 3/4" | 40 1/4" x 20 1/2" | FIT OVER 3-WIDE MULLED UNITS | | | | | |
| HR-44* | 43 1/2" x 21 3/4" | 44 1/4" x 22 1/2" | HR 3-24* | 70 3/4" x 35 3/8" | 71 1/2" x 36 1/8" | | | |
| HR-48* | 47 1/2" x 23 3/4" | 48 1/4" x 24 1/2" | HR 3-28* | 82 3/4" x 41 3/8" | 83 1/2" x 42 1/8" | | | |
| HR-60* | 59 1/2" x 29 3/4" | 60 1/4" x 30 1/2" | HR 3-32* | 94 3/4" x 47 3/8" | 95 1/2" x 48 1/8" | | | |
| HR-70* | 68 1/2" x 34 1/4" | 69 1/4" x 35" | | | | | | |
| HR-72* | 71 1/2" x 35 3/4" | 72 1/4" x 36 1/2" | | | | | | |

STANDARD GRID CONFIGURATION

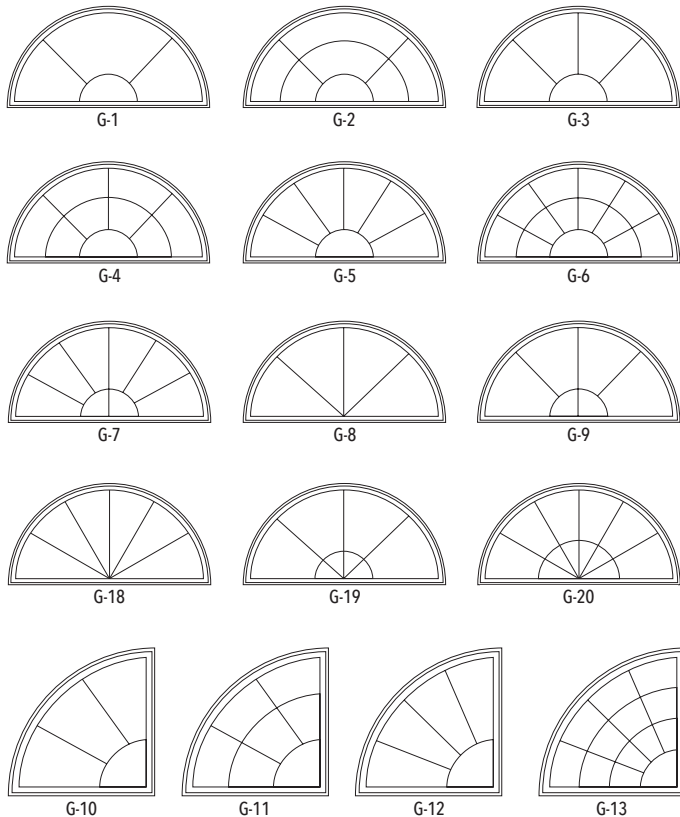

STANDARD SIZE EXTENDED 1/2 ROUND UNITS

| ORDER NO. | UNIT SIZE | ROUGH OPENING |
|----------------------------|-------------------|-------------------|
| 24" SHOULDER HEIGHT | | |
| EHR3642* | 35 1/2" x 41 3/4" | 36 1/4" x 42 1/2" |
| EHR3843* | 37" x 42 1/2" | 37 3/4" x 43 1/4" |
| EHR4848* | 47 1/2" x 47 3/4" | 48 1/4" x 48 1/2" |
| EHR6054* | 59 1/2" x 53 3/4" | 60 1/4" x 54 1/2" |
| EHR6457* | 63" x 55 1/2" | 63 3/4" x 56 1/4" |
| EHR6860* | 68 1/2" x 58 1/4" | 69 1/4" x 59" |
| EHR7260* | 71 1/2" x 59 3/4" | 72 1/4" x 60 1/2" |
| 36" SHOULDER HEIGHT | | |
| EHR3655* | 35 1/2" x 53 3/4" | 36 1/4" x 54 1/2" |
| EHR3856* | 37" x 54 1/2" | 37 3/4" x 55 1/4" |
| EHR4861* | 47 1/2" x 59 3/4" | 48 1/4" x 60 1/2" |
| EHR6067* | 59 1/2" x 65 3/4" | 60 1/4" x 66 1/2" |
| EHR6469* | 63" x 67 1/2" | 63 3/4" x 68 1/4" |
| EHR7071* | 68 1/2" x 70 1/4" | 69 1/4" x 71" |
| EHR7273* | 71 1/2" x 71 3/4" | 72 1/4" x 72 1/2" |
| 48" SHOULDER HEIGHT | | |
| EHR3666* | 35 1/2" x 65 3/4" | 36 1/4" x 66 1/2" |
| EHR3867* | 37" x 66 1/2" | 37 3/4" x 67 1/4" |
| EHR4872* | 47 1/2" x 71 3/4" | 48 1/4" x 72 1/2" |
| EHR6078* | 59 1/2" x 77 3/4" | 60 1/4" x 78 1/2" |
| 60" SHOULDER HEIGHT | | |
| EHR3678* | 35 1/2" x 77 3/4" | 36 1/4" x 78 1/2" |
| EHR3879* | 37" x 78 1/2" | 37 3/4" x 79 1/4" |
| EHR4884* | 47 1/2" x 83 3/4" | 48 1/4" x 84 1/2" |

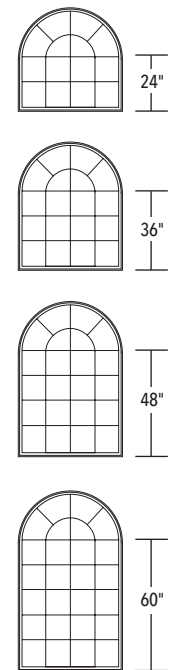

Also available as
Thermo-Tech®
ENERGY GUARD &
ENERGY GUARD PLUS
 Triple glass options.

See page 7 for performance data.
 Available in sizes noted with an "*".

Ellipse windows blend charm and beauty with the practicality of low maintenance and energy efficiency. Ellipse windows can be installed as single units or joined to fixed casements, casements, double-hungs, single-hungs, awnings, direct sets, and sliders.

To figure rough openings for stacked units, add the unit dimension height of each window, 1/8" for each mull, and 3/4". Any multiple-wide stacked unit over 63" in width needs a structural mull. This requires you to add 1-1/8" for each structural mull, and 3/4".

Also available as **Thermo-Tech® ENERGY GUARD & ENERGY GUARD PLUS Triple glass options.**

See page 7 for performance data. Available in sizes noted with an "*".

STANDARD SIZE ELLIPSE UNITS

| ORDER NO. | UNIT SIZE | ROUGH OPENING |
|--|---------------|-------------------|
| FIT OVER STANDARD SLIDERS, DIRECT-SETS & FIXED CASEMENTS | | |
| TE-48* | 47 1/2" x 16" | 48 1/4" x 16 3/4" |
| TE-60* | 59 1/2" x 16" | 60 1/4" x 16 3/4" |
| TE-68* | 67 1/2" x 16" | 68 1/4" x 16 3/4" |
| TE-72* | 71 1/2" x 20" | 72 1/4" x 20 3/4" |
| TE-96* | 95 1/2" x 20" | 96 1/4" x 20 3/4" |
| FIT OVER 2-WIDE MULLED UNITS | | |
| TE 2-24* | 47 1/8" x 16" | 47 7/8" x 16 3/4" |
| TE 2-28* | 55 1/8" x 16" | 55 7/8" x 16 3/4" |
| TE 2-32* | 63 1/8" x 16" | 63 7/8" x 16 3/4" |
| FIT OVER 3-WIDE MULLED UNITS | | |
| TE 3-24* | 70 3/4" x 20" | 71 1/2" x 20 3/4" |
| TE 3-28* | 82 3/4" x 20" | 83 1/2" x 20 3/4" |
| TE 3-32* | 94 3/4" x 20" | 95 1/2" x 20 3/4" |

STANDARD ELLIPSE WINDOW GRID CONFIGURATION

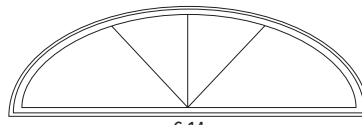

G-14



G-15

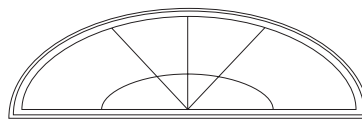

G-16

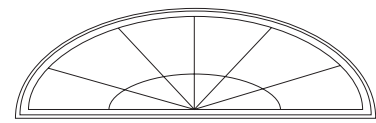

G-17

EXTENDED EYEBROW UNITS

8" Shoulder Height

| ORDER NO. | UNIT SIZE | ROUGH OPENING |
|--|-------------------|-------------------|
| FIT OVER SINGLE UNITS AND ENTRY DOORS | | |
| TEE 2816* | 27 1/2" x 16 1/2" | 28 1/4" x 17 1/4" |
| TEE 3216* | 31 1/2" x 16 1/2" | 32 1/4" x 17 1/4" |
| TEE 3616* | 35 1/2" x 16 1/2" | 36 1/4" x 17 1/4" |
| TEE 3816* | 37" x 16 1/2" | 37 3/4" x 17 1/4" |
| TEE 4016* | 39 1/2" x 16 1/2" | 40 1/4" x 17 1/4" |
| TEE 4416* | 43 1/2" x 16 1/2" | 44 1/4" x 17 1/4" |
| FIT OVER SLIDERS, FIXED CASEMENTS & DIRECT-SET | | |
| TEE 4816* | 47 1/2" x 16 1/2" | 48 1/4" x 17 1/4" |
| TEE 6020* | 59 1/2" x 19 1/2" | 60 1/4" x 20 1/4" |
| TEE 6820* | 68 1/2" x 19 1/2" | 69 1/4" x 20 1/4" |
| TEE 7220* | 71 1/2" x 19 1/2" | 72 1/4" x 20 1/4" |
| TEE 9620* | 95 1/2" x 19 1/2" | 96 1/4" x 20 1/4" |
| FIT OVER 2-WIDE MULLED UNITS | | |
| TEE 2-2416* | 47 1/8" x 16 1/2" | 47 7/8" x 17 1/4" |
| TEE 2-2816* | 55 1/8" x 16 1/2" | 55 7/8" x 17 1/4" |
| TEE 2-3220* | 63 1/8" x 19 1/2" | 63 7/8" x 20 1/4" |
| FIT OVER 3-WIDE MULLED UNITS | | |
| TEE 3-2420* | 70 3/4" x 19 1/2" | 71 1/2" x 20 1/4" |
| TEE 3-2820* | 82 3/4" x 19 1/2" | 83 3/4" x 20 1/4" |
| TEE 3-3220* | 94 3/4" x 19 1/2" | 95 1/2" x 20 1/4" |

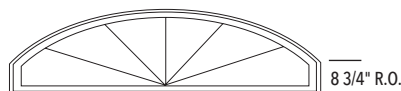

EXTENDED EYEBROW WINDOW GRID CONFIGURATION

24" Shoulder Height

| ORDER NO. | UNIT SIZE | ROUGH OPENING |
|--|-------------------|-------------------|
| FIT OVER SINGLE UNITS AND ENTRY DOORS | | |
| TEE 2833* | 27 1/2" x 32 1/2" | 28 1/4" x 33 1/4" |
| TEE 3233* | 31 1/2" x 32 1/2" | 32 1/4" x 33 1/4" |
| TEE 3633* | 35 1/2" x 32 1/2" | 36 1/4" x 33 1/4" |
| TEE 3833* | 37" x 32 1/2" | 37 3/4" x 33 1/4" |
| TEE 4033* | 39 1/2" x 32 1/2" | 40 1/4" x 33 1/4" |
| TEE 4433* | 43 1/2" x 32 1/2" | 44 1/4" x 33 1/4" |
| FIT OVER SLIDERS, FIXED CASEMENTS & DIRECT-SET | | |
| TEE 4834* | 47 1/2" x 34" | 48 1/4" x 34 3/4" |
| TEE 6034* | 59 1/2" x 34" | 60 1/4" x 34 3/4" |
| TEE 7234* | 71 1/2" x 34" | 72 1/4" x 34 3/4" |
| FIT OVER 2-WIDE MULLED UNITS | | |
| TEE 2-2434* | 47 1/8" x 34" | 47 7/8" x 34 3/4" |
| TEE 2-2834* | 55 1/8" x 34" | 55 7/8" x 34 3/4" |
| TEE 2-3234* | 63 1/8" x 34" | 63 7/8" x 34 3/4" |
| FIT OVER 3-WIDE MULLED UNITS | | |
| TEE 3-2434* | 70 3/4" x 34" | 71 1/2" x 34 3/4" |
| TEE 3-2834* | 82 3/4" x 34" | 83 1/2" x 34 3/4" |
| TEE 3-3234* | 94 3/4" x 34" | 95 1/2" x 34 3/4" |

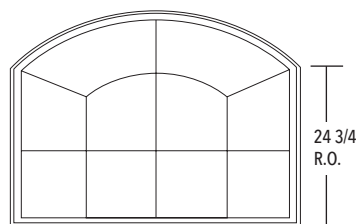

EXTENDED EYEBROW WINDOW GRID CONFIGURATION

59" Shoulder Height

| ORDER NO. | UNIT SIZE | ROUGH OPENING |
|---------------------------------------|-------------------|-------------------|
| FIT OVER SINGLE UNITS AND ENTRY DOORS | | |
| TEE 3668* | 35 1/2" x 67 1/2" | 36 1/4" x 68 1/4" |
| TEE 4868* | 47 1/2" x 67 1/2" | 48 1/4" x 68 1/4" |
| TEE 6071* | 59 1/2" x 70 1/2" | 60 1/4" x 71 1/4" |
| TEE 6871* | 68 1/2" x 70 1/2" | 69 1/4" x 71 1/4" |
| TEE 7271* | 71 1/2" x 70 1/2" | 72 1/4" x 71 1/4" |

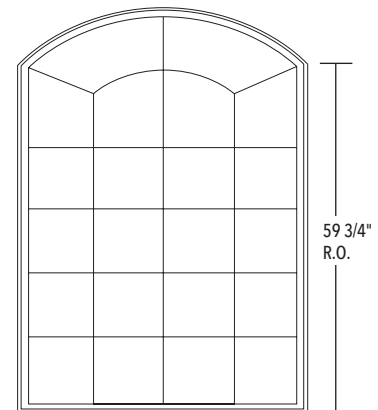

EXTENDED EYEBROW WINDOW GRID CONFIGURATION

Thermo-Tech windows can create a truly custom look with the ultimate in design features. We build each specialty window to your exact specifications. Whether you want trapezoids, triangles, hexagons, pentagons, octagons or more, Thermo-Tech's specialty windows are available in just about any angle or slope required. Use these windows as single units or combine them with any of our other window systems.

FEATURES & BENEFITS:

- Fusion welded corners.
- 100% virgin vinyl.
- Insulated sealed units with warm-edge spacer for added insulation and energy efficiency.
- Maintenance-free.
- Choice of colors White, Tan or Sandlewood.
- 3-1/4" multi-chamber frame.
- With or without grids.
- Rigid frame and sash construction for strength and durability.
- Choice of nail fin for new construction.

- Light oak or dark oak interior wood laminate.
- Upgrade to LoE³™ 366/Argon or Energy Guard LoE³™ 366/Argon triple-insulated glass.
- See other options on pages 4-5.

Also available as Thermo-Tech® ENERGY GUARD & ENERGY GUARD PLUS Triple glass options.

See page 7 for performance data. Available in sizes noted with an "*".

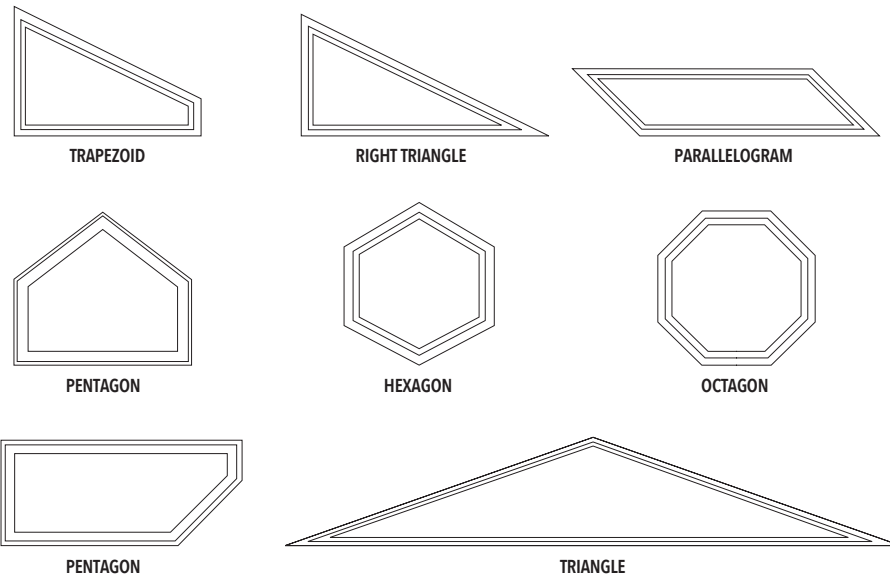

| OCTAGON AND EXTENDED OCTAGON WINDOWS | | |
|--------------------------------------|-------------------|-------------------|
| ORDER NO. | UNIT SIZE | ROUGH OPENING |
| 24" OCTAGON WINDOW | | |
| 2424* | 23 1/2" x 23 1/2" | 24 1/4" x 24 1/4" |
| 36" EXTENDED OCTAGON WINDOW | | |
| 2436* | 23 1/2" x 35 1/2" | 24 1/4" x 36 1/4" |

24" OCTAGON WINDOW

36" EXTENDED OCTAGON WINDOW

POSSIBLE COMBINATIONS

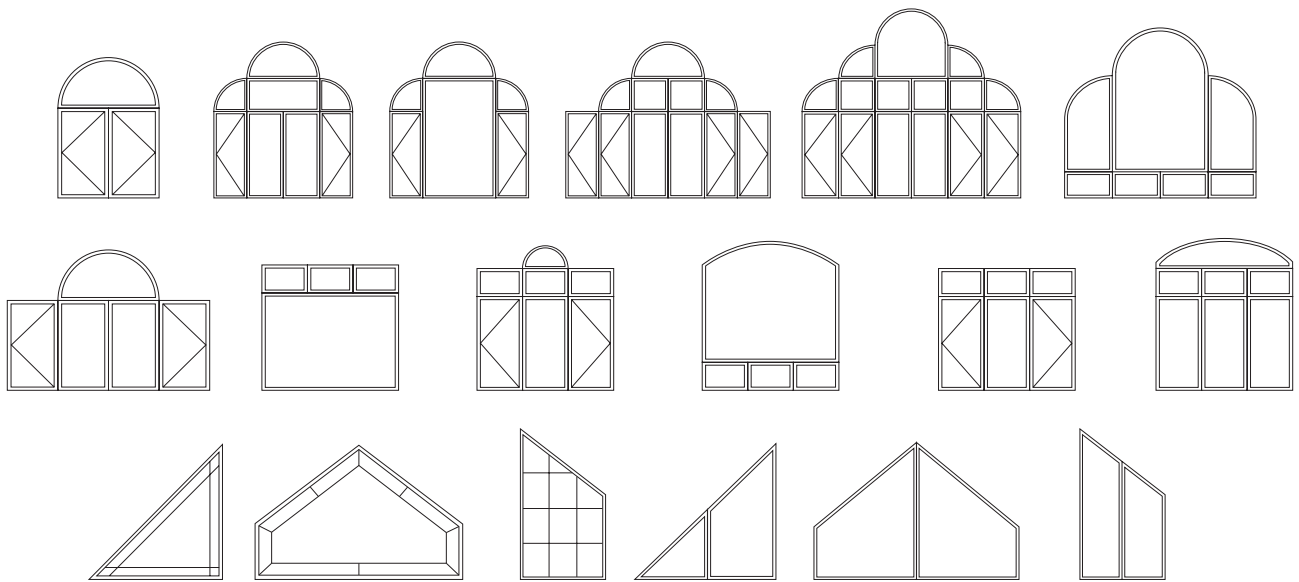

LIMITED WARRANTY

Thank you for choosing Thermo-Tech window products. All of our employees at Thermo-Tech are dedicated to the highest standards of quality which reflects in our company's reputation for workmanship, product performance and customer satisfaction. We are committed to bringing you products of the highest quality and value. We are committed to standing behind our products with quick responsive service and a comprehensive warranty. This warranty is our statement of confidence in our products and our desire to provide you with total customer satisfaction.

* This is a limited warranty and is extended to all purchasers of Thermo-Tech windows, and to subsequent owners to which this limited warranty has been properly transferred, (see warranty conditions and exclusions). Your Thermo-Tech product is warranted to be free from defects in manufacturing, materials and workmanship as provided herein. If such a defect occurs, Thermo-Tech will at its option (1) repair the defective product, (2) replace defective materials or (3) refund your purchase price.

Vinyl Frame and Sash Parts: Lifetime

Thermo-Tech warrants that the UPVC vinyl frame and sash parts (including interior laminated window material) will not rot, blister, pit, flake or peel under ordinary conditions on account of manufacturing defects in the extrusions. Thermo-Tech's obligation to this warranty is to supply replacement product only.

Window Hardware: Lifetime

Thermo-Tech warrants all window hardware shall be free from factory defects in material and workmanship for the life of the structure into which the window is installed. Thermo-Tech's obligation to this warranty is to supply replacement hardware only.

Exterior Applied Laminates: 10 Years

Thermo-Tech warrants that exterior laminates applied to vinyl surfaces will be free of manufacturing defects which result in rotting, cracking, warping, pitting, corroding, peeling, blistering, or non-uniform fading discoloration for a period of (10) years from the date of manufacture. Any color change in exterior applied laminate is warranted at greater than or equal to grayscale (3) for exposure in the U.S., Mexico, and Canada.

Insulated Glass: 20 Years

Thermo-Tech warrants the sealed insulated glass for seal failure causing impaired vision due to moisture, film or dust between the glass panes. This warranty does not include scratches, cracked or broken glass or damage caused by improper maintenance, handling or misuse, heat buildup or the application of after manufacture film on glass. Should any insulated glass unit be proven defective during the warranty period, Thermo-Tech shall provide either a replacement piece of insulated glass or a sash glazed with insulated glass, at its discretion, delivered to the original point of purchase, or shipped direct to the consumer (normal shipping and delivery charges will apply). Thereafter, Thermo-Tech will not be responsible for installation and replacement of the glass or sash.

Stress breaks in the insulated glass unit are covered for a period of (1) year from the date of manufacture. Should a stress break occur during the warranty period, Thermo-Tech shall, at its discretion, provide either a replacement insulated glass unit, or a sash glazed with an insulated glass unit, and will provide labor to replace for a period of (1) year from the date of manufacture. Labor includes replacement of unit only. Thermo-Tech requires safe access to affected unit be provided by property owner or representative. A Thermo-Tech representative must determine and pre-approve whether the damage claimed is an actual stress break.

CONDITIONS AND EXCLUSIONS:

- * THIS IS A LIMITED WARRANTY AND DOES NOT COVER LABOR, SHIPPING EXPENSES OR OTHER COSTS ASSOCIATED WITH THE INSTALLATION OR REMOVAL OF PRODUCT FOR REPAIR OR REPLACEMENT EXCEPT WHERE NOTED.
- * THERMO-TECH IS RESPONSIBLE FOR ITS PRODUCTS ONLY. INSTALLATION OR REFINISHING OF REPLACEMENT PARTS WILL BE THE RESPONSIBILITY OF THE CONSUMER.
- * EXCLUDES IMPROPER INSTALLATION, FIELD FINISHING OR MAINTENANCE.
- * EXCLUDES ADJUSTMENTS OF LOCKS, LATCHES, SASH POSITIONS OR FIT TO FRAME OR ANY OTHER ADJUSTMENTS DUE TO BUT NOT LIMITED TO STRUCTURAL EXPANSION, CONTRACTION, MOVEMENT, SETTLING OR OTHER OUTSIDE FACTORS THAT MAY AFFECT OPERATION, FUNCTION AND/OR FIT OF PRODUCT.
- * THIS LIMITED WARRANTY DOES NOT APPLY TO ANY DAMAGE OR FAILURE CAUSED BY FIRE, ACCIDENT, FLOOD, INSECTS, MISUSE, HAIL, VANDALISM, CONSTRUCTION DEBRIS, EXCESSIVE TEMPERATURES, EXPOSURE TO UNUSUAL HEAT SOURCES, OR ANY OTHER EXTERNAL FORCES SUCH AS AN ACT OF GOD. THERMO-TECH ASSUMES NO OTHER LIABILITY FOR SUBSEQUENT DAMAGES TO ANY OTHER MATERIAL THAN THE PRODUCTS IT MANUFACTURES.
- * EXCLUDES NORMAL WEAR, DISCOLORATION OR FADING OF FINISHES, INCLUDING THE TARNISHING OF METALLIC HARDWARE.
- * EXCLUDES DAMAGE CAUSED BY CHEMICALS OR SEALANTS (I.E. BRICK WASH) OR A HARSH ENVIRONMENT (I.E. SALT SPRAY OR AIRBORNE POLLUTANTS). NOTE: SEALANTS USED IN WINDOW INSTALLATION AND BUILDING CONSTRUCTION MUST BE COMPATIBLE WITH WINDOW COMPONENTS AND MATERIALS.
- * THIS WARRANTY APPLIES ONLY TO SINGLE FAMILY DWELLINGS IN WHICH THERMO-TECH WINDOWS WERE INSTALLED.
- * EXCLUDES WINDOWS AND DOORS THAT ARE INSTALLED IN STRUCTURES THAT DO NOT ALLOW FOR PROPER MOISTURE MANAGEMENT OR THE DRAINAGE OF MOISTURE SUCH AS EXTERIOR INSULATION AND FINISH SYSTEMS (EIFS), ALSO KNOWN AS SYNTHETIC STUCCO. THE SYSTEM MUST HAVE AN ENGINEERED DRAINAGE SYSTEM.
- * EXCLUDES CONDENSATION OR FROST ON THE INTERIOR OR EXTERIOR EXPOSED SURFACES. THESE CONDITIONS ARE NOT A DEFECT IN THE PRODUCT, BUT A RESULT OF EXCESSIVE HUMIDITY.
- * EXCLUDES ANY WOOD EXTENSION JAMBS OR TRIM.

THERMO-TECH RESERVES THE RIGHT TO DISCONTINUE OR CHANGE ANY THERMO-TECH WINDOW SYSTEM AS MANUFACTURED.

WE SHALL NOT BE RESPONSIBLE FOR CONSEQUENTIAL OR INCIDENTAL DAMAGES OF ANY KIND DUE TO NEGLIGENCE OR OTHERWISE. THIS WARRANTY IS IN LIEU OF ALL OTHER AGREEMENTS, UNDERSTANDINGS, AND WARRANTIES, EXPRESS OR IMPLIED, INCLUDING AN IMPLIED WARRANTY OF MERCHANTABILITY AND FITNESS FOR A PARTICULAR PURPOSE, THERE BEING NO OBLIGATIONS OR LIABILITIES ON THERMO-TECH OTHER THAN THOSE EXPRESSED IN THIS WARRANTY.

THIS WARRANTY IS NULL AND VOID IF THE PRODUCT HAS BEEN REPAIRED WITHOUT AUTHORIZATION, OR IF IT HAS BEEN ALTERED, DISASSEMBLED, OR MODIFIED.

This warranty is transferable for a period of up to three years from the date of purchase. To transfer please call 320-529-4012 or 877-565-0159. If you have a warranty claim with your Thermo-Tech window, call the dealer nearest you or from whom the products were purchased or call 320-529-4012 or 877-565-0159.

This warranty shall be governed, construed, and enforced in accordance with the laws of the State of Minnesota, without regard to its conflict of law principles. All disputes and claims shall be resolved by a court located in Stearns County, Minnesota.

Effective May 2018



ClassicSeries

by Thermo-Tech

Craftsmanship Infused
With Technology

Thermo-Tech® Classic Series Windows blend masterful craftsmanship with superior vinyl and insulated-glass technology. Homeowners gain energy savings, curb appeal and low-maintenance comfort. All from a trusted and recognized company.



1120 38th Avenue Northeast
Sauk Rapids, Minnesota 56379

Phone: 320-529-4012

Toll-Free: 1-877-565-0159

Fax: 320-529-4017

Toll-Free Fax: 1-877-565-0160

E-mail: info@thermo-techwindows.com

ttwindows.com

Choose Thermo-Tech® Classic Series Windows for standard-size new construction projects. For samples of our quality American-made products, please visit your local Thermo-Tech dealer or call 1-877-565-0159 to find the dealer nearest you. Your Thermo-Tech dealers are window and door professionals, ready to help you achieve impressive results.

Please visit us at www.ttwindows.com any time for more information.

 **Thermo-Tech**
Premium Windows and Doors